



ERNSTES  DESIGN

JEWELRY MADE IN GERMANY



HAUPTKATALOG

2023 ■ 2024

evia



ERNSTES DESIGN

JEWELRY MADE IN GERMANY



NEUHEITEN HERBST 2023

4-12



RINGE

13-28



KETTEN

29-38



EVIA SCHMUCKSETS

39-42



ANHÄNGER

43-57



OHRSCHMUCK

58-74



ARMSCHMUCK

75-85



SEILE, KETTEN

85-90



ARMSPANGENMASSE

85



ALLGEMEINE INFORMATIONEN

91

ENTWURF UND HERSTELLUNG
Andreas Ernst

ERNSTES DESIGN
Max-Born-Straße 12
48529 Nordhorn

ernstesdesign.de

matt/polirt,
Brill. TW/SI
0,02 ct.



B: ca. 6,5 mm,
Gr. 48-65

R728
139,00 €

matt/polirt,
Brill. TW/SI
0,02 ct.



ca. 8x19 mm,
Kettenöffnung 2,1 mm

AN990
135,00 €

matt/polirt,
2x Brill. TW/SI
0,02 ct.



ca. 6x11 mm

E668
239,00 €

polirt,
SW-Perle
Ø ca. 6 mm



ca. 7x28 mm,
Kettenöffnung 2,3 mm

AN991
79,00 €

polirt,
SW-Perlen
Ø ca. 6 mm



ca. 7x45 mm

E669
139,00 €

polirt, SW-Perle Ø ca. 4 mm,
Spiegelankerkette Ø 1,5 mm



L: ca. 16, 17, 18, 19, 20, 21 cm,
mit Clic-Verschluss Ø 2 mm

A593
95,00 €

matt/polirt



ca. 10x30 mm,
Kettenöffnung 3 mm

AN992
49,00 €

matt/polirt,
Gelbgold
beschichtet



ca. 10x30 mm,
Kettenöffnung 3 mm

AN993
65,00 €

matt/polirt



ca. 10x40 mm

E670
85,00 €

matt/polirt,
Gelbgold
beschichtet



ca. 10x40 mm

E671
99,00 €

matt/polirt,
Spiegelankerkette Ø 1,5 mm



L: ca. 16, 17, 18, 19, 20, 21 cm,
mit Clic-Verschluss Ø 2 mm

A596
85,00 €

matt/polirt,
teilweise Gelbgold
beschichtet,
Spiegelankerkette Ø 1,5 mm



L: ca. 16, 17, 18, 19, 20, 21 cm,
mit Clic-Verschluss Ø 2 mm

A597
95,00 €

polirt/gekratzt/matt,
Brill. TW/SI 0,02 ct.,
Spiegelankerkette Ø 1 mm



ca. 15x16 mm,
L: 42/45/50 cm,
mit Clic-Verschluss Ø 2 mm

K837
195,00 €

polirt/gekratzt/matt,
Spiegelankerkette Ø 1 mm



ca. 15x16 mm,
L: 42/45/50 cm,
mit Clic-Verschluss Ø 2 mm

K836
103,00 €

matt/polirt/gekratzt,
Brill. TW/SI 0,02 ct.,
teilweise Gelbgold beschichtet,
Spiegelankerkette Ø 1 mm



ca. 15x16 mm,
L: 42/45/50 cm,
mit Clic-Verschluss Ø 2 mm

K839
208,00 €

matt/polirt/gekratzt,
teilweise Gelbgold beschichtet,
Spiegelankerkette Ø 1 mm



ca. 15x16 mm,
L: 42/45/50 cm,
mit Clic-Verschluss Ø 2 mm

K838
115,00 €

poliert/gekratzt/matt



ca. 50x55 mm,
Kettenöffnung 5 mm

AN994
104,00 €

matt/gekratzt/polirt,
teilweise Gelbgold
beschichtet



ca. 50x55 mm,
Kettenöffnung 5 mm

AN995
125,00 €

poliert/gekratzt/matt



ca. 15x16 mm,
L: ca. 150 mm

E672
111,00 €

matt/gekratzt/polirt,
teilweise Gelbgold
beschichtet



ca. 15x16 mm,
L: ca. 150 mm

E673
135,00 €

poliert/gekratzt/matt,
Spiegelankerkette Ø 1,5 mm



L: ca. 16, 17, 18, 19, 20, 21 cm,
mit Clic-Verschluss Ø 2 mm

A594
104,00 €

matt/gekratzt/polirt,
teilweise Gelbgold
beschichtet,
Spiegelankerkette Ø 1,5 mm



L: ca. 16, 17, 18, 19, 20, 21 cm,
mit Clic-Verschluss Ø 2 mm

A595
116,00 €

gekratzt/polirt/
matt



ca. 9x24 mm

E674
109,00 €

gekratzt/matt/
polirt, teilweise
Gelbgold
beschichtet

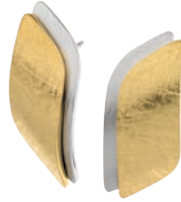

ca. 9x24 mm

E675
135,00 €

polierte Drachen-Venen-Achat-Würfel



ED **vita** petit

Ø ca. 8 mm,
L: ca. 19, 20, 21, 22, 23 cm,
mit Magnetverschluss klein ohne Gewinde

A541
79,00 €

matte Sodalith-Perlen



ED **vita** petit

Ø ca. 6 mm,
mit Magnetverschluss klein ohne Gewinde

K201
bis 50 cm: 97,00 €

matte Sodalith-Perlen



ED **vita** petit

Ø ca. 8 mm,
mit Magnetverschluss klein ohne Gewinde

K202
bis 50 cm: 105,00 €

matte Sodalith-Perlen



ED **vita** petit

Ø ca. 6 mm,
L: ca. 19, 20, 21, 22, 23 cm,
mit Magnetverschluss klein ohne Gewinde

A539
76,00 €

matte Sodalith-Perlen



ED **vita** petit

Ø ca. 8 mm,
L: ca. 19, 20, 21, 22, 23 cm,
mit Magnetverschluss klein ohne Gewinde

A540
79,00 €

matt, black-cord



ED **vita** petit

Ø ca. 6 mm,
L: ca. 19, 20, 21, 22, 23 cm,
mit Magnetverschluss klein ohne Gewinde

A542
76,00 €

matt, Schwarz beschichtet,
black-cord



ED **vita** petit

Ø ca. 6 mm,
L: ca. 19, 20, 21, 22, 23 cm,
mit Magnetverschluss klein ohne Gewinde

A543
76,00 €

poliert



EDvita poliert

B: ca. 14 mm,
Wechselschließe für
Magnetverschluss klein
ohne Gewinde

AN755
32,00 €

matt



EDvita poliert

B: ca. 14 mm,
Wechselschließe für
Magnetverschluss klein
ohne Gewinde

AN757
32,00 €

poliert, Gelbgold
beschichtet



EDvita poliert

B: ca. 14 mm,
Wechselschließe für
Magnetverschluss klein
ohne Gewinde

AN756
42,00 €

matt, Gelbgold
beschichtet



EDvita poliert

B: ca. 14 mm,
Wechselschließe für
Magnetverschluss klein
ohne Gewinde

AN758
42,00 €

poliert/gekratzt/
matt



edia

Ø ca. 17 mm,
Kettenöffnung 2,1 mm

AN972
55,00 €

poliert/gekratzt/
matt



edia

Ø ca. 25 mm,
Kettenöffnung 2,1 mm

AN974
59,00 €

poliert/gekratzt/
matt, Zirkonia
white



edia

Ø ca. 17 mm,
Kettenöffnung 2,1 mm

AN976
55,00 €

poliert/gekratzt/
matt, Zirkonia
white



edia

Ø ca. 25 mm,
Kettenöffnung 2,1 mm

AN978
59,00 €

poliert/gekratzt/
matt, Gelbgold
beschichtet



edia

Ø ca. 17 mm,
Kettenöffnung 2,1 mm

AN973
69,00 €

poliert/gekratzt/
matt, Gelbgold
beschichtet



edia

Ø ca. 25 mm,
Kettenöffnung 2,1 mm

AN975
75,00 €

poliert/gekratzt/
matt, Gelbgold
beschichtet,
Zirkonia
white



edia

Ø ca. 17 mm,
Kettenöffnung 2,1 mm

AN977
69,00 €

poliert/gekratzt/
matt, Gelbgold
beschichtet,
Zirkonia
white



edia

Ø ca. 25 mm,
Kettenöffnung 2,1 mm

AN979
75,00 €



<p>poliert</p>  <p><i>edia</i></p> <p>B: ca. 3 mm, Ø ca. 12 mm</p> <p>E632 39,00 €</p>	<p>poliert</p>  <p><i>edia</i></p> <p>B: ca. 5 mm, Ø ca. 12 mm</p> <p>E638 42,00 €</p>	<p>poliert</p>  <p><i>edia</i></p> <p>B: ca. 7 mm, Ø ca. 12 mm</p> <p>E644 45,00 €</p>
<p>poliert</p>  <p><i>edia</i></p> <p>B: ca. 3 mm, Ø ca. 16 mm</p> <p>E650 45,00 €</p>	<p>poliert</p>  <p><i>edia</i></p> <p>B: ca. 5 mm, Ø ca. 16 mm</p> <p>E656 48,00 €</p>	<p>poliert</p>  <p><i>edia</i></p> <p>B: ca. 7 mm, Ø ca. 16 mm</p> <p>E662 51,00 €</p>
<p>matt/poliert</p>  <p><i>edia</i></p> <p>B: ca. 3 mm, Ø ca. 12 mm</p> <p>E634 39,00 €</p>	<p>matt/poliert</p>  <p><i>edia</i></p> <p>B: ca. 5 mm, Ø ca. 12 mm</p> <p>E640 42,00 €</p>	<p>matt/poliert</p>  <p><i>edia</i></p> <p>B: ca. 7 mm, Ø ca. 12 mm</p> <p>E646 45,00 €</p>
<p>matt/poliert</p>  <p><i>edia</i></p> <p>B: ca. 3 mm, Ø ca. 16 mm</p> <p>E652 45,00 €</p>	<p>matt/poliert</p>  <p><i>edia</i></p> <p>B: ca. 5 mm, Ø ca. 16 mm</p> <p>E658 48,00 €</p>	<p>matt/poliert</p>  <p><i>edia</i></p> <p>B: ca. 7 mm, Ø ca. 16 mm</p> <p>E664 51,00 €</p>
<p>gekratzt/poliert</p>  <p><i>edia</i></p> <p>B: ca. 3 mm, Ø ca. 12 mm</p> <p>E636 39,00 €</p>	<p>gekratzt/poliert</p>  <p><i>edia</i></p> <p>B: ca. 5 mm, Ø ca. 12 mm</p> <p>E642 42,00 €</p>	<p>gekratzt/poliert</p>  <p><i>edia</i></p> <p>B: ca. 7 mm, Ø ca. 12 mm</p> <p>E648 45,00 €</p>
<p>gekratzt/poliert</p>  <p><i>edia</i></p> <p>B: ca. 3 mm, Ø ca. 16 mm</p> <p>E654 45,00 €</p>	<p>gekratzt/poliert</p>  <p><i>edia</i></p> <p>B: ca. 5 mm, Ø ca. 16 mm</p> <p>E660 48,00 €</p>	<p>gekratzt/poliert</p>  <p><i>edia</i></p> <p>B: ca. 7 mm, Ø ca. 16 mm</p> <p>E666 51,00 €</p>

poliert, Gelbgold
beschichtet



edia

B: ca. 3 mm,
Ø ca. 12 mm

E633
49,00 €

poliert, Gelbgold
beschichtet



edia

B: ca. 5 mm,
Ø ca. 12 mm

E639
54,00 €

poliert, Gelbgold
beschichtet



edia

B: ca. 7 mm,
Ø ca. 12 mm

E645
59,00 €

poliert, Gelbgold
beschichtet



edia

B: ca. 3 mm,
Ø ca. 16 mm

E651
55,00 €

poliert, Gelbgold
beschichtet



edia

B: ca. 5 mm,
Ø ca. 16 mm

E657
60,00 €

poliert, Gelbgold
beschichtet



edia

B: ca. 7 mm,
Ø ca. 16 mm

E663
65,00 €

matt/polier, Gelbgold
beschichtet



edia

B: ca. 3 mm,
Ø ca. 12 mm

E635
49,00 €

matt/polier, Gelbgold
beschichtet



edia

B: ca. 5 mm,
Ø ca. 12 mm

E641
54,00 €

matt/polier, Gelbgold
beschichtet



edia

B: ca. 7 mm,
Ø ca. 12 mm

E647
59,00 €

matt/polier, Gelbgold
beschichtet



edia

B: ca. 3 mm,
Ø ca. 16 mm

E653
55,00 €

matt/polier, Gelbgold
beschichtet



edia

B: ca. 5 mm,
Ø ca. 16 mm

E659
60,00 €

matt/polier, Gelbgold
beschichtet



edia

B: ca. 7 mm,
Ø ca. 16 mm

E665
65,00 €

gekratzt/polier, Gelbgold
beschichtet



edia

B: ca. 3 mm,
Ø ca. 12 mm

E637
49,00 €

gekratzt/polier, Gelbgold
beschichtet



edia

B: ca. 5 mm,
Ø ca. 12 mm

E643
54,00 €

gekratzt/polier, Gelbgold
beschichtet

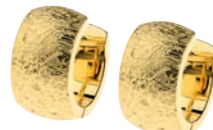

edia

B: ca. 7 mm,
Ø ca. 12 mm

E649
59,00 €

gekratzt/polier, Gelbgold
beschichtet



edia

B: ca. 3 mm,
Ø ca. 16 mm

E655
55,00 €

gekratzt/polier, Gelbgold
beschichtet



edia

B: ca. 5 mm,
Ø ca. 16 mm

E661
60,00 €

gekratzt/polier, Gelbgold
beschichtet



edia

B: ca. 7 mm,
Ø ca. 16 mm

E667
65,00 €

matt/poliert/gemustert
(A601, A602, E632, EH01,
Kettenstück+ANV16)



edia

inkl. Verpackung



Länge Collier: ca. 50 cm,
Länge Armband: ca. 17-23 cm,
Länge Ohrschmuck: ca. 4 cm

S001
156,00 €

matt/poliert/gemustert, Kunstperlen
Ø ca. 8 mm (A603, A608, E632, EH01,
Kettenstück+ANV16)



edia

inkl. Verpackung



Länge Collier: ca. 50 cm,
Länge Armband: ca. 17-23 cm,
Länge Ohrschmuck: ca. 4 cm

S002
182,00 €

matt/poliert/gemustert, Onyx- u. Spinell-Perlen
Ø ca. 6/5 mm (A605, A600, E632, EH02,
Kettenstück+ANV16)



edia

inkl. Verpackung



Länge Collier: ca. 50 cm,
Länge Armband: ca. 17-23 cm,
Länge Ohrschmuck: ca. 5,5 cm

S003
182,00 €

matt/poliert/gemustert, teilweise Gelbgold
beschichtet (A608, A606, E632, EH03,
Kettenstück+ANV17)



edia

inkl. Verpackung



Länge Collier: ca. 50 cm,
Länge Armband: ca. 17-23 cm,
Länge Ohrschmuck: ca. 5 cm

S004
166,00 €

matt/poliert/gemustert, teilweise Gelbgold
beschichtet, Kunstperlen Ø ca. 6 mm
(A604, A615, E633, EH04,
Kettenstück+ANV17)



edia

inkl. Verpackung



Länge Collier: ca. 50 cm,
Länge Armband: ca. 17-23 cm,
Länge Ohrschmuck: ca. 4,5 cm

S005
212,00 €

matt/poliert/gemustert, teilweise Gelbgold
beschichtet, Onyx- u. Spinell-Perlen Ø ca. 6/5 mm
(A605, A607, E633, EH05,
Kettenstück+ANV17)



edia

inkl. Verpackung



Länge Collier: ca. 50 cm,
Länge Armband: ca. 17-23 cm,
Länge Ohrschmuck: ca. 8 cm

S006
212,00 €

matt/poliert/gemustert, Gelbgold
beschichtet (A609, A611, E633, EH06,
Kettenstück+ANV17)



edia

inkl. Verpackung



Länge Collier: ca. 50 cm,
Länge Armband: ca. 17-23 cm,
Länge Ohrschmuck: ca. 4 cm

S007
196,00 €



poliert/gemustert

evia



L: ca. 17-23 cm

A600
39,00 €

poliert/gemustert

evia



L: ca. 17-23 cm

A601
39,00 €

poliert/gemustert

evia



L: ca. 17-23 cm

A602
39,00 €

poliert/gemustert,
Kunstperlen Ø ca. 8 mm

evia



L: ca. 17-23 cm

A603
65,00 €

poliert/gemustert,
Kunstperlen Ø ca. 6 mm



L: ca. 17-23 cm

A604
65,00 €

poliert/gemustert,
Onyx- und Spinell-Perlen
Ø ca. 6/5 mm



L: ca. 17-23 cm

A605
65,00 €

poliert/gemustert

evia



L: ca. 17-23 cm

A606
39,00 €

poliert/gemustert,
Gelbgold beschichtet

evia



L: ca. 17-23 cm

A607
49,00 €

poliert/gemustert

evia



L: ca. 17-23 cm

A608
39,00 €

poliert/gemustert,
Gelbgold beschichtet

evia



L: ca. 17-23 cm

A609
49,00 €

geriffelt/poliert/gemustert

evia



L: ca. 17-23 cm

A610
39,00 €

geriffelt/poliert/gemustert,
Gelbgold beschichtet

evia



L: ca. 17-23 cm

A611
49,00 €

geriffelt/poliert/gemustert

evia

L: ca. 17-23 cm



A612
39,00 €

geriffelt/poliert/gemustert,
Gelbgold beschichtet

evia

L: ca. 17-23 cm



A613
49,00 €

poliert/gemustert

evia

L: ca. 17-23 cm



A614
39,00 €

poliert/gemustert,
Gelbgold beschichtet

evia

L: ca. 17-23 cm



A615
49,00 €

geriffelt/poliert

evia

Länge Einhänger
ca. 3 cm



EH01
10,00 €

poliert

evia

Länge Einhänger
ca. 4,5 cm



EH02
10,00 €

poliert, Gelbgold
beschichtet

evia

Länge Einhänger
ca. 4 cm



EH03
12,00 €

poliert/geriffelt,
Gelbgold
beschichtet

evia

Länge Einhänger
ca. 3,5 cm



EH04
12,00 €

poliert, Gelbgold
beschichtet

evia

Länge Einhänger
ca. 7 cm



EH05
12,00 €

geriffelt/poliert,
Gelbgold
beschichtet

evia

Länge Einhänger
ca. 3 cm



EH06
12,00 €

gemustert/poliert

evia

Ø ca. 19 mm



ANV16
19,00 €

























gemustert/poliert,
Gelbgold
beschichtet

evia

Ø ca. 19 mm



ANV17
22,00 €

<p>matt, Platin 960/ Titan</p>  <p>R91 B: 4 mm, Gr. 48-71 562,00 €</p>	<p>matt, Platin 960/Titan, Brill. TW/SI 0,035 ct.</p>  <p>R92 B: 4 mm, Gr. 48-71 758,00 €</p>	<p>matt, Platin 960/Titan</p>  <p>R85 B: 6 mm, Gr. 48-71 580,00 €</p>	<p>matt, Platin 960/Titan, Brill. TW/SI 0,035 ct.</p>  <p>R86 B: 6 mm, Gr. 48-71 776,50 €</p>
<p>matt, Platin 960/Titan</p>  <p>R111 B: 4 mm, Gr. 48-71 462,00 €</p>	<p>matt, Platin 960/Titan, TW/SI 0,012 ct.</p>  <p>R112 B: 4 mm, Gr. 48-71 537,00 €</p>	<p>matt, Platin 960/Titan</p>  <p>R87 B: 6 mm, Gr. 48-71 813,00 €</p>	<p>matt, Platin 960/Titan, Brill. TW/SI 0,035 ct.</p>  <p>R88 B: 6 mm, Gr. 48-71 1.008,00 €</p>
<p>matt, Platin 960/Titan</p>  <p>R93 B: 7 mm, Gr. 48-71 601,00 €</p>	<p>matt, Platin 960/Titan, Dia. Princess Cut TW/SI 0,05 ct.</p>  <p>R94 B: 7 mm, Gr. 48-71 884,00 €</p>	<p>matt, 585er Gelbgold</p>  <p>R76 B: 7 mm, Gr. 48-71 218,00 €</p>	<p>matt, 585er Gelbgold, Dia. Princess Cut TW/SI 0,05 ct.</p>  <p>R77 B: 7 mm, Gr. 48-71 463,00 €</p>
<p>matt, 585er Gelbgold</p>  <p>R57 B: 4 mm, Gr. 48-71 195,00 €</p>	<p>matt, 585er Gelbgold, Brill. TW/SI 0,035 ct.</p>  <p>R58 B: 4 mm, Gr. 48-71 364,00 €</p>	<p>matt, 585er Gelbgold</p>  <p>R51 B: 6 mm, Gr. 48-71 199,00 €</p>	<p>matt, 585er Gelbgold, Brill. TW/SI 0,035 ct.</p>  <p>R52 B: 6 mm, Gr. 48-71 372,00 €</p>
<p>matt, 585er Gelbgold</p>  <p>R109 B: 4 mm, Gr. 48-71 199,00 €</p>	<p>matt, 585er Gelbgold, Brill. TW/SI 0,012 ct.</p>  <p>R110 B: 4 mm, Gr. 48-71 268,00 €</p>	<p>matt, 585er Gelbgold</p>  <p>R53 B: 6 mm, Gr. 48-71 289,00 €</p>	<p>matt, 585er Gelbgold, Brill. TW/SI 0,035 ct.</p>  <p>R54 B: 6 mm, Gr. 48-71 458,00 €</p>
<p>matt, 585er Gelbgold</p>  <p>R98 B: 6 mm, Gr. 48-71 209,00 €</p>	<p>matt, 585er Gelbgold, Brill. TW/SI 0,02 ct.</p>  <p>R99 B: 6 mm, Gr. 48-71 299,00 €</p>	<p>matt/poliert, 585er Gelbgold</p>  <p>R180 B: 8 mm, Gr. 48-71 213,00 €</p>	<p>matt/poliert, 585er Gelbgold, Brill. TW/SI 0,02 ct.</p>  <p>R181 B: 8 mm, Gr. 48-71 299,00 €</p>

<p>matt/polirt, 585er Gelbgold</p>  <p>R176 199,00 €</p> <p>B: 6 mm, Gr. 48-71</p>	<p>matt/polirt, 585er Gelbgold, Brill. TW/SI 0,02 ct.</p>  <p>R177 289,00 €</p> <p>B: 6 mm, Gr. 48-71</p>	<p>matt/polirt, 585er Gelbgold</p>  <p>R207 199,00 €</p> <p>B: 6 mm, Gr. 48-71</p>	<p>matt/polirt, 585er Gelbgold, Brill. TW/SI 0,035 ct.</p>  <p>R208 372,00 €</p> <p>B: 6 mm, Gr. 48-71</p>
<p>matt/polirt, 585er Gelbgold</p>  <p>R209 289,00 €</p> <p>B: 6 mm, Gr. 48-71</p>	<p>matt/polirt, 585er Gelbgold, Brill. TW/SI 0,035 ct.</p>  <p>R210 458,00 €</p> <p>B: 6 mm, Gr. 48-71</p>	<p>matt, 585er Gelbgold</p>  <p>R217.7 218,00 €</p> <p>B: 7 mm, Gr. 48-71</p>	<p>matt, 585er Gelbgold, Brill. TW/SI 0,035 ct.</p>  <p>R218.7 387,00 €</p> <p>B: 7 mm, Gr. 48-71</p>
<p>matt, 585er Gelbgold</p>  <p>R217.9 221,00 €</p> <p>B: 9 mm, Gr. 48-71</p>	<p>matt, 585er Gelbgold, Brill. TW/SI 0,035 ct.</p>  <p>R218.9 390,00 €</p> <p>B: 9 mm, Gr. 48-71</p>	<p>geschliffen/matt, 585er Gelbgold</p>  <p>R223.7 224,00 €</p> <p>B: 7 mm, Gr. 48-71</p>	<p>geschliffen/matt, 585er Gelbgold, Brill. TW/SI 0,035 ct.</p>  <p>R224.7 393,00 €</p> <p>B: 7 mm, Gr. 48-71</p>
<p>geschliffen/matt, 585er Gelbgold</p>  <p>R223.9 226,00 €</p> <p>B: 9 mm, Gr. 48-71</p>	<p>geschliffen/matt, 585er Gelbgold, Brill. TW/SI 0,035 ct.</p>  <p>R224.9 395,00 €</p> <p>B: 9 mm, Gr. 48-71</p>	<p>matt, 585er Gelbgold</p>  <p>R229.7 299,00 €</p> <p>B: 7 mm, Gr. 48-71</p>	<p>matt, 585er Gelbgold, Brill. TW/SI 0,035 ct.</p>  <p>R230.7 473,00 €</p> <p>B: 7 mm, Gr. 48-71</p>
<p>matt, 585er Gelbgold</p>  <p>R229.9 307,00 €</p> <p>B: 9 mm, Gr. 48-71</p>	<p>matt, 585er Gelbgold, Brill. TW/SI 0,035 ct.</p>  <p>R230.9 476,00 €</p> <p>B: 9 mm, Gr. 48-71</p>	<p>geschliffen/matt, 585er Gelbgold</p>  <p>R235.7 309,00 €</p> <p>B: 7 mm, Gr. 48-71</p>	<p>geschliffen/matt, 585er Gelbgold, Brill. TW/SI 0,035 ct.</p>  <p>R236.7 478,00 €</p> <p>B: 7 mm, Gr. 48-71</p>
<p>geschliffen/matt, 585er Gelbgold</p>  <p>R235.9 312,00 €</p> <p>B: 9 mm, Gr. 48-71</p>	<p>geschliffen/matt, 585er Gelbgold, Brill. TW/SI 0,035 ct.</p>  <p>R236.9 481,00 €</p> <p>B: 9 mm, Gr. 48-71</p>	<p>matt/polirt, 585er Roségold</p>  <p>R167 199,00 €</p> <p>B: 6 mm, Gr. 48-71</p>	<p>matt/polirt, 585er Roségold, Brill. TW/SI 0,035 ct.</p>  <p>R168 372,00 €</p> <p>B: 6 mm, Gr. 48-71</p>

<p>matt/poliert, 585er Roségold</p>  <p>R169 289,00 €</p> <p>B: 6 mm, Gr. 48-71</p>	<p>matt/poliert, 585er Roségold, Brill. TW/SI 0,035 ct.</p>  <p>R170 458,00 €</p> <p>B: 6 mm, Gr. 48-71</p>	<p>matt, 585er Roségold</p>  <p>R174 209,00 €</p> <p>B: 6 mm, Gr. 48-71</p>	<p>matt, 585er Roségold, Brill. TW/SI 0,02 ct.</p>  <p>R175 299,00 €</p> <p>B: 6 mm, Gr. 48-71</p>
<p>matt/poliert, 585er Roségold</p>  <p>R182 213,00 €</p> <p>B: 8 mm, Gr. 48-71</p>	<p>matt/poliert, 585er Roségold, Brill. TW/SI 0,02 ct.</p>  <p>R183 299,00 €</p> <p>B: 8 mm, Gr. 48-71</p>	<p>matt/poliert, 585er Roségold</p>  <p>R178 199,00 €</p> <p>B: 6 mm, Gr. 48-71</p>	<p>matt/poliert, 585er Roségold, Brill. TW/SI 0,02 ct.</p>  <p>R179 289,00 €</p> <p>B: 6 mm, Gr. 48-71</p>
<p>matt, 585er Roségold</p>  <p>R219.7 218,00 €</p> <p>B: 7 mm, Gr. 48-71</p>	<p>matt, 585er Roségold, Brill. TW/SI 0,035 ct.</p>  <p>R220.7 387,00 €</p> <p>B: 7 mm, Gr. 48-71</p>	<p>matt, 585er Roségold</p>  <p>R219.9 221,00 €</p> <p>B: 9 mm, Gr. 48-71</p>	<p>matt, 585er Roségold, Brill. TW/SI 0,035 ct.</p>  <p>R220.9 390,00 €</p> <p>B: 9 mm, Gr. 48-71</p>
<p>geschliffen/matt, 585er Roségold</p>  <p>R225.7 224,00 €</p> <p>B: 7 mm, Gr. 48-71</p>	<p>geschliffen/matt, 585er Roségold, Brill. TW/SI 0,035 ct.</p>  <p>R226.7 393,00 €</p> <p>B: 7 mm, Gr. 48-71</p>	<p>geschliffen/matt, 585er Roségold</p>  <p>R225.9 226,00 €</p> <p>B: 9 mm, Gr. 48-71</p>	<p>geschliffen/matt, 585er Roségold, Brill. TW/SI 0,035 ct.</p>  <p>R226.9 395,00 €</p> <p>B: 9 mm, Gr. 48-71</p>
<p>matt, 585er Roségold</p>  <p>R231.7 299,00 €</p> <p>B: 7 mm, Gr. 48-71</p>	<p>matt, 585er Roségold, Brill. TW/SI 0,035 ct.</p>  <p>R232.7 473,00 €</p> <p>B: 7 mm, Gr. 48-71</p>	<p>matt, 585er Roségold</p>  <p>R231.9 307,00 €</p> <p>B: 9 mm, Gr. 48-71</p>	<p>matt, 585er Roségold, Brill. TW/SI 0,035 ct.</p>  <p>R232.9 476,00 €</p> <p>B: 9 mm, Gr. 48-71</p>
<p>geschliffen/matt, 585er Roségold</p>  <p>R237.7 309,00 €</p> <p>B: 7 mm, Gr. 48-71</p>	<p>geschliffen/matt, 585er Roségold, Brill. TW/SI 0,035 ct.</p>  <p>R238.7 478,00 €</p> <p>B: 7 mm, Gr. 48-71</p>	<p>geschliffen/matt, 585er Roségold</p>  <p>R237.9 312,00 €</p> <p>B: 9 mm, Gr. 48-71</p>	<p>geschliffen/matt, 585er Roségold, Brill. TW/SI 0,035 ct.</p>  <p>R238.9 481,00 €</p> <p>B: 9 mm, Gr. 48-71</p>

<p>matt/polier</p>  <p>R215.7 53,50 €</p> <p>B: 7 mm, Gr. 48-71</p>	<p>matt/polier, Brill. TW/SI 0,02 ct.</p>  <p>R216.7 157,50 €</p> <p>B: 7 mm, Gr. 48-71</p>	<p>matt/polier</p>  <p>R215.9 56,00 €</p> <p>B: 9 mm, Gr. 48-71</p>	<p>matt/polier, Brill. TW/SI 0,02 ct.</p>  <p>R216.9 160,00 €</p> <p>B: 9 mm, Gr. 48-71</p>
<p>matt/polier</p>  <p>R227.7 53,50 €</p> <p>B: 7 mm, Gr. 48-71</p>	<p>matt/polier, Brill. TW/SI 0,02 ct.</p>  <p>R228.7 157,50 €</p> <p>B: 7 mm, Gr. 48-71</p>	<p>matt/polier</p>  <p>R227.9 56,00 €</p> <p>B: 9 mm, Gr. 48-71</p>	<p>matt/polier, Brill. TW/SI 0,02 ct.</p>  <p>R228.9 160,00 €</p> <p>B: 9 mm, Gr. 48-71</p>
<p>geschliffen/polier</p>  <p>R221.7 59,00 €</p> <p>B: 7 mm, Gr. 48-71</p>	<p>geschliffen/polier, Brill. TW/SI 0,02 ct.</p>  <p>R222.7 164,00 €</p> <p>B: 7 mm, Gr. 48-71</p>	<p>geschliffen/polier</p>  <p>R221.9 63,00 €</p> <p>B: 9 mm, Gr. 48-71</p>	<p>geschliffen/polier, Brill. TW/SI 0,02 ct.</p>  <p>R222.9 166,50 €</p> <p>B: 9 mm, Gr. 48-71</p>
<p>geschliffen/polier</p>  <p>R233.7 59,00 €</p> <p>B: 7 mm, Gr. 48-71</p>	<p>geschliffen/polier, Brill. TW/SI 0,02 ct.</p>  <p>R234.7 164,00 €</p> <p>B: 7 mm, Gr. 48-71</p>	<p>geschliffen/polier</p>  <p>R233.9 63,00 €</p> <p>B: 9 mm, Gr. 48-71</p>	<p>geschliffen/polier, Brill. TW/SI 0,02 ct.</p>  <p>R234.9 166,50 €</p> <p>B: 9 mm, Gr. 48-71</p>
<p>matt</p>  <p>R64.4 30,50 €</p> <p>B: 4 mm, Gr. 48-71</p>	<p>matt, Brill. TW/SI 0,02 ct.</p>  <p>R65.4 138,00 €</p> <p>B: 4 mm, Gr. 48-71</p>	<p>matt</p>  <p>R64.6 35,00 €</p> <p>B: 6 mm, Gr. 48-71</p>	<p>matt, Brill. TW/SI 0,02 ct.</p>  <p>R65.6 140,50 €</p> <p>B: 6 mm, Gr. 48-71</p>
<p>matt</p>  <p>R64.8 38,00 €</p> <p>B: 8 mm, Gr. 48-71</p>	<p>matt, Brill. TW/SI 0,02 ct.</p>  <p>R65.8 144,50 €</p> <p>B: 8 mm, Gr. 48-71</p>	<p>matt</p>  <p>R66.4 39,50 €</p> <p>B: 4 mm, Gr. 48-71</p>	<p>matt, Brill. TW/SI 0,02 ct.</p>  <p>R67.4 144,50 €</p> <p>B: 4 mm, Gr. 48-71</p>

<p>matt</p>  <p>R66.6 44,00 €</p> <p>B: 6 mm, Gr. 48-71</p>	<p>matt, Brill. TW/SI 0,02 ct.</p>  <p>R67.6 147,00 €</p> <p>B: 6 mm, Gr. 48-71</p>	<p>matt</p>  <p>R66.8 45,00 €</p> <p>B: 8 mm, Gr. 48-71</p>	<p>matt, Brill. TW/SI 0,02 ct.</p>  <p>R67.8 150,00 €</p> <p>B: 8 mm, Gr. 48-71</p>
<p>matt/poliert</p>  <p>R133.4 43,50 €</p> <p>B: 4 mm, Gr. 48-71</p>	<p>matt/poliert, Brill. TW/SI 0,02 ct.</p>  <p>R134.4 148,50 €</p> <p>B: 4 mm, Gr. 48-71</p>	<p>matt/poliert</p>  <p>R133.6 46,50 €</p> <p>B: 6 mm, Gr. 48-71</p>	<p>matt/poliert, Brill. TW/SI 0,02 ct.</p>  <p>R134.6 151,00 €</p> <p>B: 6 mm, Gr. 48-71</p>
<p>matt/poliert</p>  <p>R135 49,00 €</p> <p>B: 7 mm, Gr. 48-71</p>	<p>matt/poliert, Brill. TW/SI 0,02 ct.</p>  <p>R136 157,50 €</p> <p>B: 7 mm, Gr. 48-71</p>	<p>matt/poliert</p>  <p>R137.4 43,50 €</p> <p>B: 4 mm, Gr. 48-71</p>	<p>matt/poliert, Brill. TW/SI 0,02 ct.</p>  <p>R138.4 148,50 €</p> <p>B: 4 mm, Gr. 48-71</p>
<p>matt/poliert</p>  <p>R137.6 46,50 €</p> <p>B: 6 mm, Gr. 48-71</p>	<p>matt/poliert, Brill. TW/SI 0,02 ct.</p>  <p>R138.6 151,00 €</p> <p>B: 6 mm, Gr. 48-71</p>	<p>matt/poliert</p>  <p>R137.8 49,00 €</p> <p>B: 8 mm, Gr. 48-71</p>	<p>matt/poliert, Brill. TW/SI 0,02 ct.</p>  <p>R138.8 157,50 €</p> <p>B: 8 mm, Gr. 48-71</p>
<p>matt/poliert</p>  <p>R139 49,00 €</p> <p>B: 6 mm, Gr. 48-71</p>	<p>matt/poliert, Brill. TW/SI 0,02 ct.</p>  <p>R140 157,50 €</p> <p>B: 6 mm, Gr. 48-71</p>	<p>matt/poliert</p>  <p>R141 49,00 €</p> <p>B: 6 mm, Gr. 48-71</p>	<p>matt/poliert, Brill. TW/SI 0,02 ct.</p>  <p>R142 157,50 €</p> <p>B: 6 mm, Gr. 48-71</p>
<p>matt</p>  <p>R143.5 43,50 €</p> <p>B: 5 mm, Gr. 48-71</p>	<p>matt, Brill. TW/SI 0,02 ct.</p>  <p>R144.5 148,50 €</p> <p>B: 5 mm, Gr. 48-71</p>	<p>matt</p>  <p>R143.7 46,50 €</p> <p>B: 7 mm, Gr. 48-71</p>	<p>matt, Brill. TW/SI 0,02 ct.</p>  <p>R144.7 151,00 €</p> <p>B: 7 mm, Gr. 48-71</p>

<p>matt/poliert</p>  <p>R145.6 59,00 €</p> <p>B: 6 mm, Gr. 48-71</p>	<p>matt/poliert, Brill. TW/SI 0,02 ct.</p>  <p>R146.6 164,00 €</p> <p>B: 6 mm, Gr. 48-71</p>	<p>matt/poliert</p>  <p>R145.8 63,00 €</p> <p>B: 8 mm, Gr. 48-71</p>	<p>matt/poliert, Brill. TW/SI 0,02 ct.</p>  <p>R146.8 166,50 €</p> <p>B: 8 mm, Gr. 48-71</p>
<p>geschliffen</p>  <p>R360.4 35,00 €</p> <p>B: 4 mm, Gr. 48-71</p>	<p>geschliffen, Brill. TW/SI 0,02 ct.</p>  <p>R361.4 140,50 €</p> <p>B: 4 mm, Gr. 48-71</p>	<p>geschliffen</p>  <p>R360.6 38,00 €</p> <p>B: 6 mm, Gr. 48-71</p>	<p>geschliffen, Brill. TW/SI 0,02 ct.</p>  <p>R361.6 144,50 €</p> <p>B: 6 mm, Gr. 48-71</p>
<p>geschliffen</p>  <p>R360.8 41,00 €</p> <p>B: 8 mm, Gr. 48-71</p>	<p>geschliffen, Brill. TW/SI 0,02 ct.</p>  <p>R361.8 147,00 €</p> <p>B: 8 mm, Gr. 48-71</p>	<p>geschliffen/poliert</p>  <p>R366.6 44,00 €</p> <p>B: 6 mm, Gr. 48-71</p>	<p>geschliffen/poliert, Brill. TW/SI 0,02 ct.</p>  <p>R367.6 147,00 €</p> <p>B: 6 mm, Gr. 48-71</p>
<p>poliert</p>  <p>R600 49,00 €</p> <p>B: ca. 3,5 mm, Gr. 48-71</p>	<p>poliert, Brill. TW/SI 0,035 ct.</p>  <p>R603 182,00 €</p> <p>B: ca. 3,5 mm, Gr. 48-71</p>	<p>poliert</p>  <p>R601 53,50 €</p> <p>B: ca. 5 mm, Gr. 48-71</p>	<p>poliert, Brill. TW/SI 0,035 ct.</p>  <p>R604 185,00 €</p> <p>B: ca. 5 mm, Gr. 48-71</p>
<p>poliert, Brill. TW/SI 0,065 ct.</p>  <p>R605 299,00 €</p> <p>B: ca. 5 mm, Gr. 48-71</p>	<p>poliert</p>  <p>R602 56,00 €</p> <p>B: ca. 6,5 mm, Gr. 48-71</p>	<p>poliert, Brill. TW/SI 0,035 ct.</p>  <p>R606 187,50 €</p> <p>B: ca. 6,5 mm, Gr. 48-71</p>	<p>poliert, Brill. TW/SI 0,065 ct.</p>  <p>R607 308,50 €</p> <p>B: ca. 6,5 mm, Gr. 48-71</p>
<p>geschliffen/poliert</p>  <p>R610 49,00 €</p> <p>B: ca. 3,5 mm, Gr. 48-71</p>	<p>geschliffen/poliert, Brill. TW/SI 0,035 ct.</p>  <p>R613 182,00 €</p> <p>B: ca. 3,5 mm, Gr. 48-71</p>	<p>geschliffen/poliert</p>  <p>R611 53,50 €</p> <p>B: ca. 5 mm, Gr. 48-71</p>	<p>geschliffen/poliert, Brill. TW/SI 0,035 ct.</p>  <p>R614 185,00 €</p> <p>B: ca. 5 mm, Gr. 48-71</p>

<p>geschliffen/poliert, Brill. TW/SI 0,065 ct.</p>  <p>B: ca. 5 mm, Gr. 48-71</p> <p>R615 299,00 €</p>	<p>geschliffen/poliert</p>  <p>B: ca. 6,5 mm, Gr. 48-71</p> <p>R612 56,00 €</p>	<p>geschliffen/poliert, Brill. TW/SI 0,035 ct.</p>  <p>B: ca. 6,5 mm, Gr. 48-71</p> <p>R616 187,50 €</p>	<p>geschliffen/poliert, Brill. TW/SI 0,065 ct.</p>  <p>B: ca. 6,5 mm, Gr. 48-71</p> <p>R617 308,50 €</p>
<p>eismatt/poliert</p>  <p>B: ca. 3,5 mm, Gr. 48-71</p> <p>R620 49,00 €</p>	<p>eismatt/poliert, Brill. TW/SI 0,035 ct.</p>  <p>B: ca. 3,5 mm, Gr. 48-71</p> <p>R623 182,00 €</p>	<p>eismatt/poliert</p>  <p>B: ca. 5 mm, Gr. 48-71</p> <p>R621 53,50 €</p>	<p>eismatt/poliert, Brill. TW/SI 0,035 ct.</p>  <p>B: ca. 5 mm, Gr. 48-71</p> <p>R624 185,00 €</p>
<p>eismatt/poliert, Brill. TW/SI 0,065 ct.</p>  <p>B: ca. 5 mm, Gr. 48-71</p> <p>R625 299,00 €</p>	<p>eismatt/poliert</p>  <p>B: ca. 6,5 mm, Gr. 48-71</p> <p>R622 56,00 €</p>	<p>eismatt/poliert, Brill. TW/SI 0,035 ct.</p>  <p>B: ca. 6,5 mm, Gr. 48-71</p> <p>R626 187,50 €</p>	<p>eismatt/poliert, Brill. TW/SI 0,065 ct.</p>  <p>B: ca. 6,5 mm, Gr. 48-71</p> <p>R627 308,50 €</p>
<p>geschliffen/poliert</p>  <p>B: ca. 3,5 mm, Gr. 48-71</p> <p>R630 49,00 €</p>	<p>geschliffen/poliert, Brill. TW/SI 0,035 ct.</p>  <p>B: ca. 3,5 mm, Gr. 48-71</p> <p>R633 182,00 €</p>	<p>geschliffen/poliert</p>  <p>B: ca. 5 mm, Gr. 48-71</p> <p>R631 53,50 €</p>	<p>geschliffen/poliert, Brill. TW/SI 0,035 ct.</p>  <p>B: ca. 5 mm, Gr. 48-71</p> <p>R634 185,00 €</p>
<p>geschliffen/poliert, Brill. TW/SI 0,065 ct.</p>  <p>B: ca. 5 mm, Gr. 48-71</p> <p>R635 299,00 €</p>	<p>geschliffen/poliert</p>  <p>B: ca. 6,5 mm, Gr. 48-71</p> <p>R632 56,00 €</p>	<p>geschliffen/poliert, Brill. TW/SI 0,035 ct.</p>  <p>B: ca. 6,5 mm, Gr. 48-71</p> <p>R636 187,50 €</p>	<p>geschliffen/poliert, Brill. TW/SI 0,065 ct.</p>  <p>B: ca. 6,5 mm, Gr. 48-71</p> <p>R637 308,50 €</p>
<p>geschliffen/poliert</p>  <p>B: ca. 3,5 mm, Gr. 48-71</p> <p>R640 49,00 €</p>	<p>geschliffen/poliert, Brill. TW/SI 0,035 ct.</p>  <p>B: ca. 3,5 mm, Gr. 48-71</p> <p>R643 182,00 €</p>	<p>geschliffen/poliert</p>  <p>B: ca. 5 mm, Gr. 48-71</p> <p>R641 53,50 €</p>	<p>geschliffen/poliert, Brill. TW/SI 0,035 ct.</p>  <p>B: ca. 5 mm, Gr. 48-71</p> <p>R644 185,00 €</p>

<p>geschliffen/poliert, Brill. TW/SI 0,065 ct.</p>  <p>B: ca. 5 mm, Gr. 48-71</p> <p>R645 299,00 €</p>	<p>geschliffen/poliert</p>  <p>B: ca. 6,5 mm, Gr. 48-71</p> <p>R642 56,00 €</p>	<p>geschliffen/poliert, Brill. TW/SI 0,035 ct.</p>  <p>B: ca. 6,5 mm, Gr. 48-71</p> <p>R646 187,50 €</p>	<p>geschliffen/poliert, Brill. TW/SI 0,065 ct.</p>  <p>B: ca. 6,5 mm, Gr. 48-71</p> <p>R647 308,50 €</p>
<p>matt/facettiert/poliert</p>  <p>B: ca. 3,5 mm, Gr. 48-71</p> <p>R650 49,00 €</p>	<p>matt/facettiert/poliert, Brill. TW/SI 0,035 ct.</p>  <p>B: ca. 3,5 mm, Gr. 48-71</p> <p>R653 182,00 €</p>	<p>matt/facettiert/poliert</p>  <p>B: ca. 5 mm, Gr. 48-71</p> <p>R651 53,50 €</p>	<p>matt/facettiert/poliert, Brill. TW/SI 0,035 ct.</p>  <p>B: ca. 5 mm, Gr. 48-71</p> <p>R654 185,00 €</p>
<p>matt/facettiert/poliert, Brill. TW/SI 0,065 ct.</p>  <p>B: ca. 5 mm, Gr. 48-71</p> <p>R655 299,00 €</p>	<p>matt/facettiert/poliert</p>  <p>B: ca. 6,5 mm, Gr. 48-71</p> <p>R652 56,00 €</p>	<p>matt/facettiert/poliert, Brill. TW/SI 0,035 ct.</p>  <p>B: ca. 6,5 mm, Gr. 48-71</p> <p>R656 187,50 €</p>	<p>matt/facettiert/poliert, Brill. TW/SI 0,065 ct.</p>  <p>B: ca. 6,5 mm, Gr. 48-71</p> <p>R657 308,50 €</p>
<p>matt/graviert/poliert</p>  <p>B: ca. 3,5 mm, Gr. 48-71</p> <p>R660 49,00 €</p>	<p>matt/graviert/poliert, Brill. TW/SI 0,035 ct.</p>  <p>B: ca. 3,5 mm, Gr. 48-71</p> <p>R663 182,00 €</p>	<p>matt/graviert/poliert</p>  <p>B: ca. 5 mm, Gr. 48-71</p> <p>R661 53,50 €</p>	<p>matt/graviert/poliert, Brill. TW/SI 0,035 ct.</p>  <p>B: ca. 5 mm, Gr. 48-71</p> <p>R664 185,00 €</p>
<p>matt/graviert/poliert, Brill. TW/SI 0,065 ct.</p>  <p>B: ca. 5 mm, Gr. 48-71</p> <p>R665 299,00 €</p>	<p>matt/graviert/poliert</p>  <p>B: ca. 6,5 mm, Gr. 48-71</p> <p>R662 56,00 €</p>	<p>matt/graviert/poliert, Brill. TW/SI 0,035 ct.</p>  <p>B: ca. 6,5 mm, Gr. 48-71</p> <p>R666 187,50 €</p>	<p>matt/graviert/poliert, Brill. TW/SI 0,065 ct.</p>  <p>B: ca. 6,5 mm, Gr. 48-71</p> <p>R667 308,50 €</p>
<p>matt/graviert/poliert</p>  <p>B: ca. 3,5 mm, Gr. 48-71</p> <p>R670 49,00 €</p>	<p>matt/graviert/poliert, Brill. TW/SI 0,035 ct.</p>  <p>B: ca. 3,5 mm, Gr. 48-71</p> <p>R673 182,00 €</p>	<p>matt/graviert/poliert</p>  <p>B: ca. 5 mm, Gr. 48-71</p> <p>R671 53,50 €</p>	<p>matt/graviert/poliert, Brill. TW/SI 0,035 ct.</p>  <p>B: ca. 5 mm, Gr. 48-71</p> <p>R674 185,00 €</p>

matt/graviert/poliert,
Brill. TW/SI 0,065 ct.



B: ca. 5 mm,
Gr. 48-71

R675
299,00 €

matt/graviert/poliert



B: ca. 6,5 mm,
Gr. 48-71

R672
56,00 €

matt/graviert/poliert,
Brill. TW/SI 0,035 ct.



B: ca. 6,5 mm,
Gr. 48-71

R676
187,50 €

matt/graviert/poliert,
Brill. TW/SI 0,065 ct.



B: ca. 6,5 mm,
Gr. 48-71

R677
308,50 €

matt/poliert,
6x Brill. TW/SI,
insg. 0,07 ct.



B: ca. 6 mm,
Gr. 48-71

R678
408,50 €

matt/poliert,
7x Brill. TW/SI,
insg. 0,10 ct.



B: ca. 8 mm,
Gr. 48-71

R679
532,00 €

poliert,
Brill. TW/SI 0,016 ct.



B: 2 mm, Gr. 48-65

R352
104,00 €

poliert,
Brill. TW/SI 0,035 ct.



B: 2 mm, Gr. 48-65

R353
187,50 €

poliert,
Brill. TW/SI 0,065 ct.



B: 2 mm, Gr. 48-65

R354
299,00 €

matt/poliert,
Brill. TW/SI 0,10 ct.



B: ca. 3 mm,
Gr. 48-65

R717
465,00 €

matt/poliert,
Brill. TW/SI 0,15 ct.



B: ca. 3 mm,
Gr. 48-65

R718
675,00 €

matt/poliert,
Brill. TW/SI 0,25 ct.



B: ca. 3 mm,
Gr. 48-65

R719
1239,00 €

matt/poliert,
Brill. TW/SI 0,065 ct.



B: ca. 2,5 mm,
Gr. 48-65

R704
299,00 €

matt/poliert,
Brill. TW/SI 0,10 ct.



B: ca. 3 mm,
Gr. 48-65

R705
465,50 €

matt/poliert,
Brill. TW/SI 0,15 ct.



B: ca. 3,5 mm,
Gr. 48-65

R706
673,50 €

matt/poliert,
Brill. TW/SI 0,25 ct.



B: ca. 4 mm,
Gr. 48-65

R707
1.240,50 €

matt/poliert,
Brill. TW/SI 0,02 ct.



B: ca. 3 mm, Gr. 48-65

R504
139,50 €

poliert,
Brill. TW/SI 0,02 ct.



B: ca. 3 mm, Gr. 48-65

R505
139,50 €

matt/poliert,
Brill. TW/SI 0,035 ct.



B: ca. 3 mm, Gr. 48-65

R506
182,00 €

poliert,
Brill. TW/SI 0,035 ct.



B: ca. 3 mm, Gr. 48-65

R507
182,00 €

matt/poliert,
Brill. TW/SI 0,065 ct.



B: ca. 3 mm, Gr. 48-65

R508
294,00 €

poliert,
Brill. TW/SI 0,065 ct.



B: ca. 3 mm, Gr. 48-65

R509
294,00 €

matt/poliert,
Brill. TW/SI 0,02 ct.



B: ca. 5 mm, Gr. 48-65

R510
146,00 €

poliert,
Brill. TW/SI 0,02 ct.



B: ca. 5 mm, Gr. 48-65

R511
146,00 €

matt/polier
Brill. TW/SI 0,035 ct.



R512
B: ca. 5 mm, Gr. 48-65 185,00 €

poliert,
Brill. TW/SI 0,035 ct.



R513
B: ca. 5 mm, Gr. 48-65 185,00 €

matt/polier
Brill. TW/SI 0,065 ct.



R514
B: ca. 5 mm, Gr. 48-65 299,00 €

poliert,
Brill. TW/SI 0,065 ct.



R515
B: ca. 5 mm, Gr. 48-65 299,00 €

matt/polier,
Brill. TW/SI 0,10 ct.



R516
B: ca. 5 mm, Gr. 48-65 465,50 €

poliert,
Brill. TW/SI 0,10 ct.



R517
B: ca. 5 mm, Gr. 48-65 465,50 €

matt/polier,
Brill. TW/SI 0,15 ct.



R518
B: ca. 5 mm, Gr. 48-65 673,50 €

poliert,
Brill. TW/SI 0,15 ct.



R519
B: ca. 5 mm, Gr. 48-65 673,50 €

matt/polier,
Brill. TW/SI 0,25 ct.



R520
B: ca. 5 mm, Gr. 48-65 1.240,50 €

poliert,
Brill. TW/SI 0,25 ct.



R521
B: ca. 5 mm, Gr. 48-65 1.240,50 €

matt/polier,
Brill. TW/SI 0,02 ct.



R547
B: ca. 1,5 mm,
Gr. 48-65 146,00 €

poliert,
Brill. TW/SI 0,02 ct.



R723
B: ca. 4 mm,
Gr. 48-65 129,00 €

matt/polier,
Brill. TW/SI 0,02 ct.



R702
B: ca. 5 mm, Gr. 48-65 139,50 €

matt/polier,
Brill. TW/SI 0,02 ct.



R720
B: ca. 5 mm,
Gr. 48-65 149,00 €

matt/polier,
Brill. TW/SI
0,02 ct.



R728
B: ca. 6,5 mm,
Gr. 48-65 139,00 €

matt/polier/
gekratzt,
Brill. TW/SI
0,02 ct.



R714
B: ca. 5 mm,
Ø Ringkopf ca. 13 mm,
Gr. 48-65 176,00 €

matt/polier/
gekratzt, teilweise
Gelbgold
beschichtet,
Brill. TW/SI
0,02 ct.



R715
B: ca. 5 mm,
Ø Ringkopf ca. 13 mm,
Gr. 48-65 196,50 €

matt/polier,
teilweise Schwarz
beschichtet,
Brill. TW/SI 0,02 ct.



R522
B: 4 mm, Gr. 48-65 169,00 €

matt/polier,
585er Gelbgold
Brill. TW/SI 0,02 ct.



R523
B: 4 mm, Gr. 48-65 209,50 €

matt/polier,
585er Roségold
Brill. TW/SI 0,02 ct.



R524
B: 4 mm, Gr. 48-65 209,50 €

matt/polier/graviert



R500
B: ca. 10 mm, Gr. 48-65 76,00 €

matt/polier/graviert



R501
B: ca. 13 mm, Gr. 48-65 78,50 €

matt/polier/
gekratzt



R700
B: ca. 7 mm,
Ø Ringkopf ca. 20 mm,
Gr. 48-65 104,00 €

matt/polier/gekratzt

B: ca. 8 mm,
Gr. 48-65

R721
99,00 €

matt/polier/ gekratzt

B: ca. 1,5 mm,
Ø Ringkopf ca. 11 mm,
Gr. 48-65

R724
79,00 €

poliert/gekratzt

B: ca. 8 mm,
Gr. 48-65

R726
79,00 €

matt/polier/gekratzt,
teilweise Gelbgold
beschichtet

B: ca. 8 mm,
Gr. 48-65

R722
129,00 €

matt/polier/ gekratzt, teilweise
Gelbgold
beschichtet

B: ca. 1,5 mm,
Ø Ringkopf ca. 11 mm,
Gr. 48-65

R725
95,00 €

matt/polier/ gekratzt, teilweise
Gelbgold
beschichtet

B: ca. 8 mm,
Gr. 48-65

R727
95,00 €

matt/polier,
SW-Perle
Ø ca. 4 mm

Gr. 48-65

R703
104,00 €

matt/polier,
SW-Perlen
Ø 4/5/7 mm

B: ca. 2 mm,
Gr. 48-65

R716
159,00 €

matt/polier/gekratzt,
SW-Perle
Ø ca. 6 mm

B: ca. 5 mm, Gr. 48-65

R545
85,50 €

matt/polier/gekratzt,
SW-Perle
Ø ca. 7 mm

B: ca. 10 mm, Gr. 48-65

R546
92,00 €

matt/polier,
SW-Perle
Ø ca. 6 mm

B: 5 mm, Gr. 48-62

R123
78,50 €

matt/polier,
SW-Perle
Ø ca. 7 mm

B: 10 mm, Gr. 48-62

R124
85,50 €

matt, SW-Perle
Ø ca. 7 mm

B: 2 mm, Gr. 48-62

R95
85,50 €

matt, SW-Perle
Ø ca. 7 mm,
Brill. TW/SI
0,016 ct.

B: 2 mm, Gr. 48-62

R122
160,00 €

matt/polier,
SW-Button-Perle
Ø ca. 6 mm

B: 8 mm, Gr. 48-62

R147
97,50 €

matt, teilweise Gelb-
gold beschichtet,
SW-Button-Perle
Ø ca. 6 mm

B: 8 mm, Gr. 48-62

R148
123,00 €

geschliffen/polier,
SW-Button-Perle
Ø ca. 7 mm

B: 5 mm, Gr. 48-62

R371.5
66,00 €

geschliffen/polier,
SW-Button-Perle
Ø ca. 7 mm

B: 7 mm, Gr. 48-62

R371.7
69,00 €

geschliffen/polier,
Gelbgold beschichtet,
SW-Button-Perle
Ø ca. 7 mm

B: 5 mm, Gr. 48-62

R372.5
85,50 €

geschliffen/polier,
Gelbgold beschichtet,
SW-Button-Perle
Ø ca. 7 mm

B: 7 mm, Gr. 48-62

R372.7
92,00 €

geschliffen/polier,
Roségold beschichtet,
SW-Button-Perle
Ø ca. 7 mm

B: 5 mm, Gr. 48-62

R373.5
85,50 €

geschliffen/polier,
Roségold beschichtet,
SW-Button-Perle
Ø ca. 7 mm

B: 7 mm, Gr. 48-62

R373.7
92,00 €

matt/graviert,
silk wood braun



R409
B: 8 mm, Gr. 48-71
73,00 €

matt/graviert,
silk wood braun



R412
B: 10 mm, Gr. 48-71
76,00 €

matt/graviert,
silk wood braun



R421
B: 8 mm, Gr. 48-71
73,00 €

matt/graviert,
silk wood braun



R424
B: 10 mm, Gr. 48-71
76,00 €

matt/graviert,
silk wood schwarz



R408
B: 8 mm, Gr. 48-71
73,00 €

matt/graviert,
silk wood schwarz



R411
B: 10 mm, Gr. 48-71
76,00 €

matt/graviert,
silk wood schwarz



R420
B: 8 mm, Gr. 48-71
73,00 €

matt/graviert,
silk wood schwarz



R423
B: 10 mm, Gr. 48-71
76,00 €

matt/graviert,
silk wood
schwarz/braun



R410
B: 8 mm, Gr. 48-71
73,00 €

matt/graviert,
silk wood
schwarz/braun



R413
B: 10 mm, Gr. 48-71
76,00 €

matt/graviert,
silk wood
schwarz/braun



R422
B: 8 mm, Gr. 48-71
73,00 €

matt/graviert,
silk wood
schwarz/braun



R425
B: 10 mm, Gr. 48-71
76,00 €

matt/graviert,
silk wood braun



R415
B: 10 mm, Gr. 48-71
76,00 €

matt/graviert,
silk wood schwarz



R414
B: 10 mm, Gr. 48-71
76,00 €

matt/graviert,
silk wood
schwarz/braun



R416
B: 10 mm, Gr. 48-71
76,00 €

poliert, Gelb- oder Roségold beschichtet



R450 30,50 € R451 49,00 € R452 49,00 €

B: 2 mm, Gr. 48-65

poliert, Gelb- oder Roségold beschichtet



R530 35,00 € R531 53,50 € R532 53,50 €

B: 5 mm, Gr. 48-65

matt/polier/facettiert, Gelb- oder Roségold beschichtet



R539 39,50 € R540 57,50 € R541 57,50 €

B: 2 mm, Gr. 48-65

matt/polier/facettiert, Gelb- oder Roségold beschichtet



R542 44,00 € R543 60,50 € R544 60,50 €

B: 5 mm, Gr. 48-65

poliert/geschliffen, Gelb- oder Roségold beschichtet



R533 39,50 € R534 57,50 € R535 57,50 €

B: 2 mm, Gr. 48-65

poliert/geschliffen, Gelb- oder Roségold beschichtet



R536 44,00 € R537 60,50 € R538 60,50 €

B: 5 mm, Gr. 48-65

poliert/gekratzt, Gelb- oder Roségold beschichtet



R471 63,00 € R472 78,50 € R473 78,50 €

B: 2 mm, Gr. 48-65

poliert/gekratzt, Gelb- oder Roségold beschichtet



R474 66,00 € R475 82,50 € R476 82,50 €

B: 2 mm, Gr. 48-65

poliert, Gelb- oder Roségold beschichtet, Zirkonia white



R453.WH 76,00 € R454.WH 95,00 € R455.WH 95,00 €

B: 2 mm, Gr. 48-65

poliert, Gelb- oder Roségold beschichtet, Zirkonia white



R456.WH 69,00 € R457.WH 85,50 € R458.WH 85,50 €

B: 2 mm, Gr. 48-65

poliert, Gelb- oder Roségold beschichtet, Zirkonia white



R462.WH 78,50 € R463.WH 97,50 € R464.WH 97,50 €

B: 2 mm, Gr. 48-65

poliert, Gelb- oder Roségold beschichtet, Zirkonia white



R459.WH 73,00 € R460.WH 92,00 € R461.WH 92,00 €

B: 2 mm, Gr. 48-65

poliert, Gelb- oder Roségold beschichtet, Zirkonia white



R465.WH 63,00 €
R466.WH 78,50 €
R467.WH 78,50 €

B: 2 mm, Gr. 48-65

poliert, Gelb- oder Roségold beschichtet, Zirkonia white



R468.WH 66,00 €
R469.WH 82,50 €
R470.WH 82,50 €

B: 2 mm, Gr. 48-65

poliert, Gelb- oder Roségold beschichtet, SW-Button-Perle Ø ca. 5 mm



R489 63,00 €
R490 78,50 €
R491 78,50 €

B: 2 mm, Gr. 48-65

poliert, Gelb- oder Roségold beschichtet, SW-Button-Perle Ø ca. 6 mm



R492 66,00 €
R493 82,50 €
R494 82,50 €

B: 2 mm, Gr. 48-65

matt/gekratzt, Gelb- oder Roségold beschichtet



R581 44,00 €
R582 60,50 €
R583 60,50 €

B: ca. 6 mm, Gr. 48-65

poliert, Gelb- oder Roségold beschichtet



R584 39,50 €
R585 57,50 €
R586 57,50 €

B: ca. 2 mm, Gr. 48-65

poliert, Gelb- oder Roségold beschichtet



R587 44,00 €
R588 60,50 €
R589 60,50 €

B: ca. 4 mm, Gr. 48-65

poliert, Zirkonia white teilausgefasst, Gelb- oder Roségold beschichtet



R590 59,00 €
R591 76,00 €
R592 76,00 €

B: ca. 2 mm, Gr. 48-65

poliert, Zirkonia white, Gelb- oder Roségold beschichtet



R593 76,00 €
R594 95,00 €
R595 95,00 €

B: ca. 2 mm, Gr. 48-65



matt/poliert, Gelb-
oder Roségold
beschichtet,
Zirkonia white



B: ca. 4 mm,
Gr. 48-65

R550 101,50 €
R551 123,00 €
R552 123,00 €

matt/poliert, Gelb-
oder Roségold
beschichtet,
Zirkonia white



B: ca. 5 mm,
Gr. 48-65

R553 107,00 €
R554 130,00 €
R555 130,00 €

matt/poliert, Gelb-
oder Roségold
beschichtet,
Zirkonia white



B: ca. 6 mm,
Gr. 48-65

R556 107,00 €
R557 107,00 €
R558 130,00 €
R559 130,00 €

matt/poliert, Gelb-
oder Roségold
beschichtet,
Zirkonia white



B: ca. 3 mm,
Gr. 48-65

R560 101,50 €
R561 123,00 €
R562 123,00 €

matt/poliert, Gelb-
oder Roségold
beschichtet



B: ca. 3 mm,
Gr. 48-65

R563 39,50 €
R564 39,50 €
R565 57,50 €
R566 57,50 €

matt/poliert, Gelb-
oder Roségold
beschichtet



B: ca. 3 mm,
Gr. 48-65

R567 39,50 €
R568 39,50 €
R569 57,50 €
R570 57,50 €

matt/poliert, Gelb-
oder Roségold
beschichtet,
Zirkonia white



B: ca. 4 mm,
Gr. 48-65

R571 101,50 €
R572 123,00 €
R573 123,00 €

matt/poliert, Gelb-
oder Roségold
beschichtet,
Zirkonia white



B: ca. 4 mm,
Gr. 48-65

R574 76,00 €
R575 101,50 €
R576 101,50 €

matt/poliert, Gelb-
oder Roségold
beschichtet,
Zirkonia white



B: ca. 5 mm,
Gr. 48-65

R577 107,00 €
R578 107,00 €
R579 130,00 €
R580 130,00 €

matt/poliert, Zirkonia
white, Gelb- oder
Roségold beschichtet



B: ca. 4 mm, Gr. 48-65

R708 97,50 €
R709 120,50 €
R710 120,50 €

matt/poliert, Zirkonia
white, Gelb- oder
Roségold beschichtet



B: ca. 6 mm, Gr. 48-65

R711 104,00 €
R712 126,00 €
R713 126,00 €

matt/poliert



B: 2/4/6 mm, Gr. 48-65

R250
35,00 €

R251
38,00 €

R252
41,00 €

poliert



B: 2/4/6 mm, Gr. 48-65

R253
35,00 €

R254
38,00 €

R255
41,00 €

matt/geschliffen



B: 2/4/6 mm, Gr. 48-65

R262
35,00 €

R263
38,00 €

R264
41,00 €

matt/poliert,
3 Wellen



B: 3/5 mm, Gr. 48-65

R303
41,00 €

R304
43,50 €

matt,
1 Welle,
Zirkonia white



B: 3/5 mm, Gr. 48-65

R301
49,00 €

R302
53,50 €

matt/poliert,
3 Wellen,
Zirkonia white



B: 3/5 mm, Gr. 48-65

R305
69,00 €

R306
70,50 €

matt/poliert,
Gelbgold beschichtet



B: 2/4/6 mm, Gr. 48-65

R256
53,50 €

R257
56,00 €

R258
59,00 €

matt/poliert,
Roségold
beschichtet



B: 2/4/6 mm, Gr. 48-65

R259
53,50 €

R260
56,00 €

R261
59,00 €

matt/poliert,
Altbronze beschichtet



B: 2/4/6 mm, Gr. 48-65

R280
53,50 €

R281
56,00 €

R282
59,00 €

matt/poliert, Zirkonia
white/black



B: 2,5 mm, Gr. 48-65

R265.WH
95,00 €

R265.BL
95,00 €

matt/poliert,
Zirkonia white



B: 2 mm, Gr. 48-65

R268
43,50 €



matt/polirt, Brill. TW/SI 0,016 ct.,
Spiegelankerkette
Ø 1 mm



ca. 3x11 mm, L: 42/45/50 cm,
mit Bajonett-Verschluss Ø 1,8 mm

K740
134,00 €

poliert, Brill. TW/SI 0,016 ct.,
Spiegelankerkette
Ø 1 mm



ca. 3x11 mm, L: 42/45/50 cm,
mit Bajonett-Verschluss Ø 1,8 mm

K741
134,00 €

matt/polirt, Brill. TW/SI 0,02 ct.,
Spiegelankerkette Ø 1 mm



ca. 3x11 mm, L: 42/45/50 cm,
mit Clic-Verschluss Ø 2 mm

K820
185,00 €

matt/polirt,
Brill. TW/SI 0,02ct.,
Drahtseil Ø 0,63 mm



ca. 27x1,5 mm,
L: 42/45/50 cm,
mit Clic-Verschluss Ø 2 mm

K800
185,00 €

matt/polirt,
Brill. TW/SI 0,02 ct.,
Spiegelankerkette Ø 1 mm



ca. 27x1,5 mm,
L: 42/45/50 cm,
mit Clic-Verschluss Ø 2 mm

K801
185,00 €

matt/polirt,
Brill. TW/SI 0,02 ct.,
Drahtseil Ø 0,63 mm



ca. 36x8 mm,
L: 42/45/50 cm,
mit Clic-Verschluss Ø 2 mm

K802
196,50 €

matt/polirt,
Brill. TW/SI 0,02 ct.,
Spiegelankerkette Ø 1 mm



ca. 8x28 mm,
L: 42/45/50 cm,
mit Clic-Verschluss Ø 2 mm

K803
196,50 €

matt/polirt,
Brill. TW/SI 0,02 ct.,
Spiegelankerkette Ø 1 mm



ca. 39x7 mm,
L: 42/45/50 cm,
mit Clic-Verschluss Ø 2 mm

K825
189,00 €

poliert,
Brill. TW/SI 0,02 ct.,
Spiegelankerkette Ø 1 mm



ca. 43x4 mm,
L: 42/45/50 cm,
mit Clic-Verschluss Ø 2 mm

K830
185,00 €

matt/polirt/gekratzt,
Brill. TW/SI 0,02 ct.,
Spiegelankerkette Ø 1 mm



Ø ca. 12 mm,
L: 42/45/50 cm,
mit Clic-Verschluss Ø 2 mm

K831
189,00 €

matt/polirt/gekratzt,
Brill. TW/SI 0,02 ct.,
Spiegelankerkette Ø 1,5 mm



ca. 30x10 mm,
L: 42/45/50 cm,
mit Clic-Verschluss Ø 2 mm

K826
219,00 €

matt/polirt/gekratzt,
Brill. TW/SI 0,02 ct.,
teilweise Gelbgold beschichtet,
Spiegelankerkette Ø 1,5 mm



ca. 30x10 mm,
L: 42/45/50 cm,
mit Clic-Verschluss Ø 2 mm

K827
239,00 €

matt/poliert/gekratzt,
Brill. TW/SI 0,02 ct.,
Spiegelankerkette Ø 1 mm



ca. 10x12 mm,
L: 42/45/50 cm,
mit Clic-Verschluss Ø 2 mm

K815
196,50 €

matt/poliert/gekratzt,
Spiegelankerkette Ø 1 mm



ca. 10x12 mm,
L: 42/45/50 cm,
mit Clic-Verschluss Ø 2 mm

K812
104,00 €

matt/poliert/gekratzt,
Brill. TW/SI 0,02 ct.,
teilweise Gelbgold beschichtet,
Spiegelankerkette Ø 1 mm



ca. 10x12 mm,
L: 42/45/50 cm,
mit Clic-Verschluss Ø 2 mm

K816
209,50 €

matt/poliert/gekratzt,
teilweise Gelbgold beschichtet,
Spiegelankerkette Ø 1 mm



ca. 10x12 mm,
L: 42/45/50 cm,
mit Clic-Verschluss Ø 2 mm

K813
116,50 €

matt/poliert/gekratzt,
Brill. TW/SI 0,02 ct.,
teilweise Roségold beschichtet,
Spiegelankerkette Ø 1 mm



ca. 10x12 mm,
L: 42/45/50 cm,
mit Clic-Verschluss Ø 2 mm

K817
209,50 €

matt/poliert/gekratzt,
teilweise Roségold beschichtet
Spiegelankerkette Ø 1 mm



ca. 10x12 mm,
L: 42/45/50 cm,
mit Clic-Verschluss Ø 2 mm

K814
116,50 €

poliert/gekratzt/matt,
Brill. TW/SI 0,02 ct.,
Spiegelankerkette Ø 1 mm



ca. 15x16 mm,
L: 42/45/50 cm,
mit Clic-Verschluss Ø 2 mm

K837
195,00 €

poliert/gekratzt/matt,
Spiegelankerkette Ø 1 mm



ca. 15x16 mm,
L: 42/45/50 cm,
mit Clic-Verschluss Ø 2 mm

K836
103,00 €

matt/poliert/gekratzt,
Brill. TW/SI 0,02 ct.,
teilweise Gelbgold beschichtet,
Spiegelankerkette Ø 1 mm



ca. 15x16 mm,
L: 42/45/50 cm,
mit Clic-Verschluss Ø 2 mm

K839
208,00 €

matt/poliert/gekratzt,
teilweise Gelbgold beschichtet,
Spiegelankerkette Ø 1 mm



ca. 15x16 mm,
L: 42/45/50 cm,
mit Clic-Verschluss Ø 2 mm

K838
115,00 €

matt, teilweise
Gelbgold beschichtet



Ø ca. 5 mm,
mit Bajonett-Verschluss Ø 5 mm

K82
bis 42 cm: 132,50 €

matt



Ø ca. 5 mm,
mit Bajonett-Verschluss Ø 5 mm

K81
bis 42 cm: 116,50 €

poliert/gekratzt,
teilweise Gelbgold
beschichtet



L: 90 cm,
ohne Verschluss

K128
146,00 €

poliert/gekratzt,
teilweise Roségold
beschichtet



L: 90 cm,
ohne Verschluss

K129
146,00 €

poliert/gekratzt



L: 90 cm,
ohne Verschluss

K127
130,00 €

matt/
poliert



Anhänger: Ø ca. 50 mm,
L: 90 cm oder 100 cm,
ohne Verschluss

K806
78,50 €

poliert, teilweise
Gelbgold
beschichtet

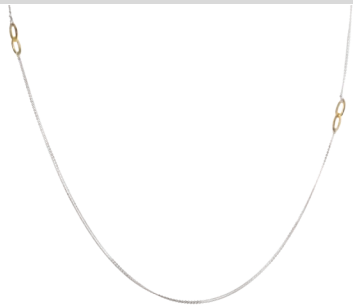

L: 90 cm oder 100 cm,
ohne Verschluss

K833
75,00 €

poliert, teilweise
Gelbgold
beschichtet



L: 90 cm oder 100 cm,
ohne Verschluss

K835
89,00 €

poliert



L: 90 cm oder 100 cm,
ohne Verschluss

K832
65,00 €

poliert



L: 90 cm oder 100 cm,
ohne Verschluss

K834
75,00 €

poliert

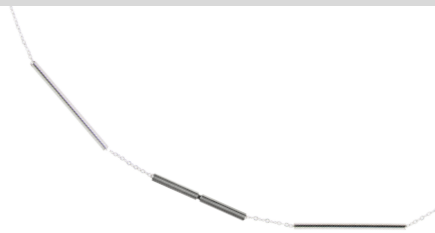

L: 42/45/50 cm,
mit Clic-Verschluss Ø 2 mm

K829
82,00 €

poliert

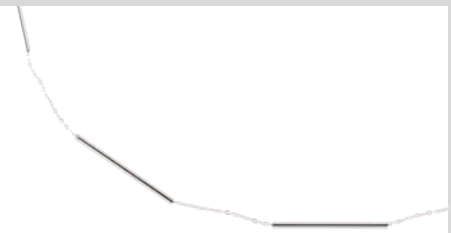

L: 42/45/50 cm,
mit Bajonett-Verschluss Ø 1,8 mm

K828
69,00 €

matt, teilweise
Gelbgold beschichtet,
SW-Perlen Ø ca. 4 mm



Ø ca. 3,5 mm,
mit Bajonett-Verschluss Ø 3,5 mm

K72
bis 42 cm: 143,00 €

matt, SW-Perlen Ø ca. 4 mm



Ø ca. 3,5 mm,
mit Bajonett-Verschluss Ø 3,5 mm

K71
bis 42 cm: 135,00 €

matt, SW-Perle Ø ca. 7 mm,
Brill. TW/SI 0,016 ct.,
Drahtseil Ø 0,63 mm



Anhänger-Länge ca. 30 mm,
mit Bajonett-Verschluss

K84
bis 50 cm: 157,50 €

matt, Gelbgold beschichtet,
SW-Perle Ø ca. 7 mm,
Drahtseil Ø 0,63 mm

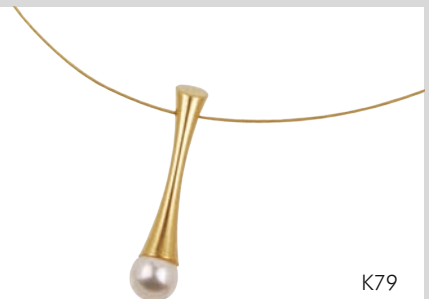

Anhänger-Länge ca. 30 mm,
mit Bajonett-Verschluss

K79
bis 50 cm: 126,00 €

matt, SW-Perle Ø ca. 7 mm,
Drahtseil Ø 0,63 mm



Anhänger-Länge ca. 30 mm,
mit Bajonett-Verschluss

K77
bis 50 cm: 82,50 €

matt, SW-Perlen
Ø ca. 4 mm,
Brill. TW/SI ca. 0,016 ct.



Anhänger Ø ca. 10 mm,
mit Bajonett-Verschluss Ø 3,5 mm

K73
bis 42 cm: 209,50 €

matt, SW-Perlen
Ø ca. 4 mm,
Brill. TW/SI ca. 0,016 ct.



Anhänger ca. 10x10 mm,
mit Bajonett-Verschluss Ø 3,5 mm

K74
bis 42 cm: 209,50 €

matt/poliert,
SW-Perle Ø ca. 7 mm,
Spiegelankerkette Ø 1 mm



Anhänger-Länge ca. 30 mm,
L: 42/45/50 cm, mit Clic-Verschluss Ø 2 mm

K822
116,50 €

matt/poliert,
SW-Perle Ø ca. 6 mm,
Spiegelankerkette Ø 1 mm



Anhänger-Länge ca. 21 mm,
L: 42/45/50 cm, mit Clic-Verschluss Ø 2 mm

K821
101,50 €

matt, SW-Perlen
Ø 4/5/7 mm,
Drahtseil Ø 0,63 mm



ca. 50x2 mm,
L: 42/45/50 cm,
mit Clic-Verschluss Ø 2 mm

K823
189,00 €

matt, SW-Perlen
Ø 4/5/7 mm,
Spiegelankerkette Ø 1,5 mm



ca. 50x2 mm,
L: 42/45/50 cm,
mit Clic-Verschluss Ø 2 mm

K824
189,00 €

matt/poliert,
SW-Perle Ø ca. 4 mm,
Drahtseil Ø 0,63 mm



ca. 27x1,5 mm,
L: 42/45/50 cm,
mit Clic-Verschluss Ø 2 mm

K818
104,00 €

matt/poliert,
SW-Perle Ø ca. 4 mm,
Spiegelankerkette Ø 1 mm



ca. 27x1,5 mm,
L: 42/45/50 cm,
mit Clic-Verschluss Ø 2 mm

K819
104,00 €

Königskette

matt/polier



Ø ca. 5 mm,
mit Magnetverschluss groß mit Gewinde

K136
bis 45 cm: 134,00 €

Königskette

matt/polier



Ø ca. 9 mm,
mit Magnetverschluss groß mit Gewinde

K105
bis 45 cm: 148,50 €

Strickkette

matt



Ø ca. 7 mm,
mit Magnetverschluss groß mit Gewinde

K133
bis 45 cm: 95,00 €

matt/polier



Ø ca. 12 mm,
mit Magnetverschluss groß mit Gewinde

K134
bis 45 cm: 257,50 €

Zopf

matt/polier

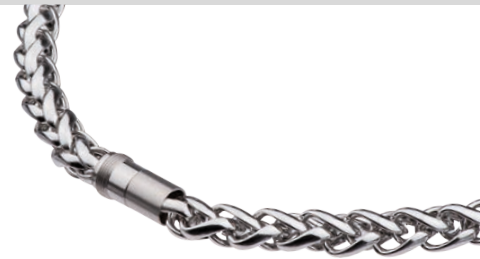

Ø ca. 8 mm,
mit Magnetverschluss groß mit Gewinde

K140
bis 45 cm: 130,00 €

Olivenkette

matt/polier



Ø ca. 12 mm,
mit Magnetverschluss groß mit Gewinde

K146
bis 45 cm: 212,00 €

matt/polier



Ø ca. 8 mm,
mit Magnetverschluss groß mit Gewinde

K191
bis 45 cm: 148,50 €

Königskette

zweifarbig, matt/polier,
teilweise Gelbgold
beschichtet

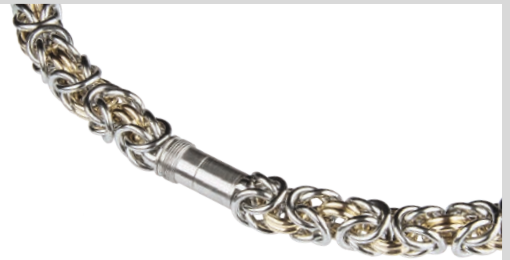

Ø ca. 9 mm,
mit Magnetverschluss groß mit Gewinde

K143
bis 45 cm: 235,50 €

Olivenkette

zweifarbig, matt/polier,
teilweise Gelbgold
beschichtet



Ø ca. 12 mm,
mit Magnetverschluss groß mit Gewinde

K147
bis 45 cm: 235,50 €

Königskette

zweifarbig, matt/polier,
teilweise Roségold
beschichtet

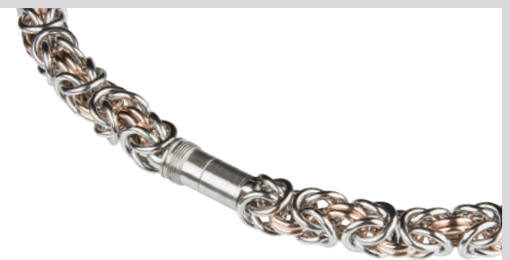

Ø ca. 9 mm,
mit Magnetverschluss groß mit Gewinde

K144
bis 45 cm: 235,50 €

Olivenkette

zweifarbig, matt/polier,
teilweise Roségold
beschichtet



Ø ca. 12 mm,
mit Magnetverschluss groß mit Gewinde

K148
bis 45 cm: 235,50 €

Königskette

zweifarbig, matt/
polier, teilweise Schwarz
beschichtet

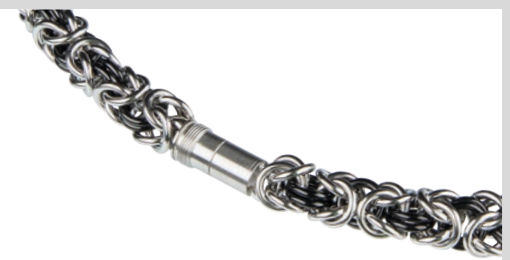

Ø ca. 9 mm,
mit Magnetverschluss groß mit Gewinde

K145
bis 45 cm: 235,50 €

matt, Leder



Ø ca. 6 mm,
mit Magnetverschluss groß mit Gewinde

K111.HB K111.DB K111.SW
bis 60 cm: je 88,00 €

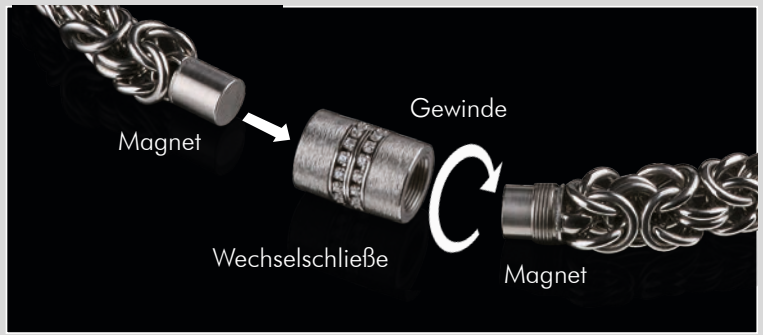

matt/graviert,
silk wood braun,
Lederband
dunkelbraun



ca. 17x34 mm,
mit Bajonett-
Verschluss
Ø 2,7 mm

K606.B
bis 60 cm: 95,00 €

matt/graviert,
silk wood braun,
Lederband
dunkelbraun



ca. 17x34 mm,
mit Bajonett-
Verschluss
Ø 2,7 mm

K609.B
bis 60 cm: 95,00 €

matt/graviert,
silk wood braun,
Lederband
dunkelbraun



Ø ca. 28 mm,
mit Bajonett-
Verschluss
Ø 2,7 mm

K656.B
bis 60 cm: 95,00 €

matt/graviert,
silk wood braun,
Lederband
dunkelbraun



Ø ca. 28 mm,
mit Bajonett-
Verschluss
Ø 2,7 mm

K668.B
bis 60 cm: 95,00 €

matt/graviert,
silk wood braun,
Lederband
dunkelbraun



ca. 17x34 mm,
mit Bajonett-
Verschluss
Ø 2,7 mm

K624.B
bis 60 cm: 95,00 €

matt/graviert,
silk wood braun,
Lederband
dunkelbraun



Ø ca. 28 mm,
mit Bajonett-
Verschluss
Ø 2,7 mm

K677.B
bis 60 cm: 95,00 €

matt/graviert,
silk wood
schwarz,
Lederband
schwarz



ca. 17x34 mm,
mit Bajonett-
Verschluss
Ø 2,7 mm

K624.S
bis 60 cm: 95,00 €

matt/graviert,
silk wood
schwarz,
Lederband
schwarz



Ø ca. 28 mm,
mit Bajonett-
Verschluss
Ø 2,7 mm

K677.S
bis 60 cm: 95,00 €

poliert/graviert,
Schwarz beschichtet,
silk wood
braun,
Lederband
dunkelbraun



ca. 17x34 mm,
mit Bajonett-
Verschluss
Ø 2,7 mm

K602.B
bis 60 cm: 107,00 €

poliert/graviert,
Schwarz beschichtet,
silk wood
braun,
Lederband
dunkelbraun



Ø ca. 28 mm,
mit Bajonett-
Verschluss
Ø 2,7 mm

K652.B
bis 60 cm: 107,00 €

matt/graviert,
silk wood
schwarz,
Lederband
schwarz



ca. 17x34 mm,
mit Bajonett-
Verschluss
Ø 2,7 mm

K600.S
bis 60 cm: 95,00 €

matt/graviert,
silk wood
schwarz,
Lederband
schwarz



Ø ca. 28 mm,
mit Bajonett-
Verschluss
Ø 2,7 mm

K679.S
bis 60 cm: 95,00 €

matt/graviert,
silk wood
schwarz,
Lederband
schwarz



Ø ca. 28 mm,
mit Bajonett-
Verschluss
Ø 2,7 mm

K681.S
bis 60 cm: 95,00 €

matt/polier



Ø ca. 5 mm,
mit Magnetverschluss klein ohne Gewinde

K189
bis 50 cm: 101,50 €

matt/polier

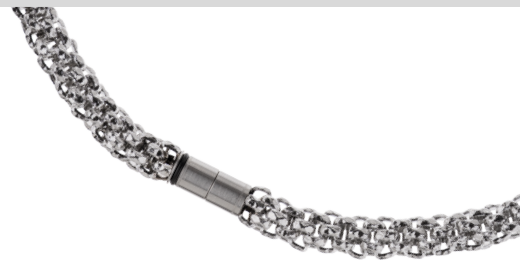

Ø ca. 8 mm,
mit Magnetverschluss klein ohne Gewinde

K188
bis 45 cm: 148,50 €

Königskette

matt/polier



Ø ca. 5 mm,
mit Magnetverschluss klein ohne Gewinde

K184
bis 45 cm: 134,00 €

antik-matt

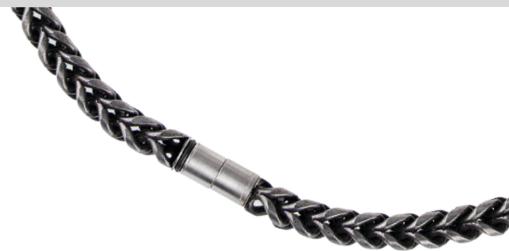

Ø ca. 6 mm,
mit Magnetverschluss klein ohne Gewinde

K194
bis 50 cm: 97,50 €

poliert

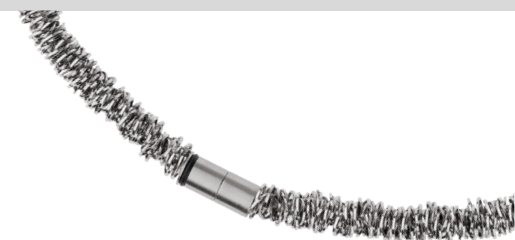

Ø ca. 6,5 mm,
mit Magnetverschluss klein ohne Gewinde

K195
bis 45 cm: 235,50 €

Königskette

zweifarbig, matt/polier,
teilweise Gelbgold
beschichtet

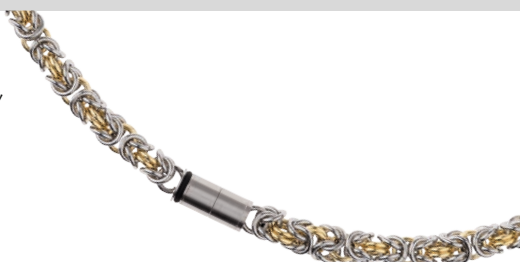

Ø ca. 5 mm,
mit Magnetverschluss klein ohne Gewinde

K185
bis 45 cm: 212,00 €

Königskette

zweifarbig, matt/polier,
teilweise Roségold
beschichtet

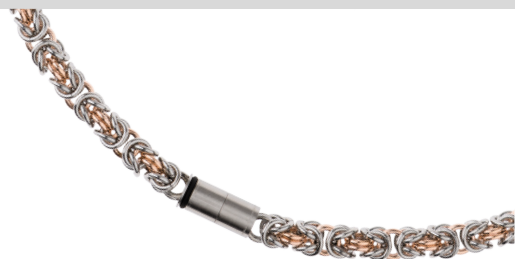

Ø ca. 5 mm,
mit Magnetverschluss klein ohne Gewinde

K186
bis 45 cm: 212,00 €

Königskette

zweifarbig, matt/polier,
teilweise Schwarz
beschichtet

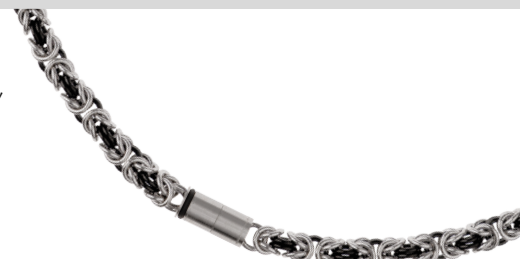

Ø ca. 5 mm,
mit Magnetverschluss klein ohne Gewinde

K187
bis 45 cm: 212,00 €

antik-matt



Ø ca. 5 mm,
mit Magnetverschluss klein ohne Gewinde

K196
bis 50 cm: 97,50 €

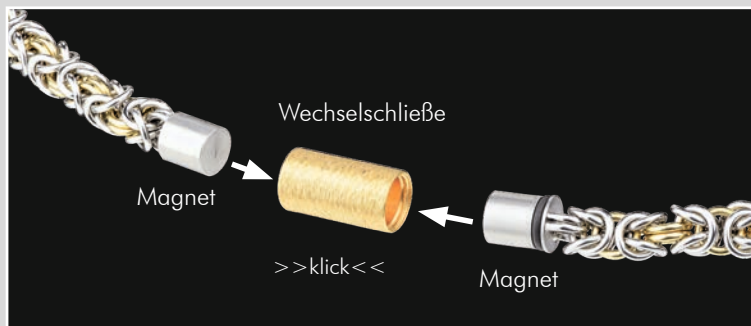

WechselschlieÙe

Magnet

>>klick<<

Magnet

SW-Perlen



Ø ca. 6 mm,
mit Magnetverschluss klein ohne Gewinde

K182
bis 45 cm: 176,00 €

SW-Perlen



Ø ca. 8 mm,
mit Magnetverschluss klein ohne Gewinde

K183
bis 45 cm: 299,00 €

matte Onyx-Perlen



Ø ca. 6 mm,
mit Magnetverschluss klein ohne Gewinde

K180
bis 50 cm: 97,50 €

matte Onyx-Perlen



Ø ca. 8 mm,
mit Magnetverschluss klein ohne Gewinde

K181
bis 50 cm: 104,00 €

matte Onyx-Linsen



Ø ca. 6 mm,
mit Magnetverschluss klein ohne Gewinde

K192
bis 50 cm: 97,50 €

matte Onyx-Linsen

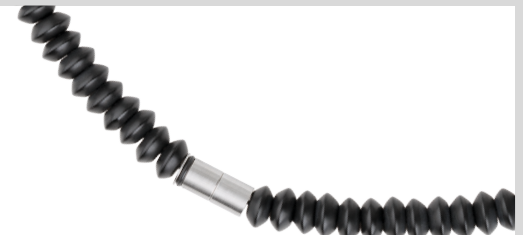

Ø ca. 8 mm,
mit Magnetverschluss klein ohne Gewinde

K193
bis 50 cm: 104,00 €

matte Silberauge-Perlen



Ø ca. 6 mm,
mit Magnetverschluss klein ohne Gewinde

K197
bis 50 cm: 97,00 €

matte Silberauge-Perlen



Ø ca. 8 mm,
mit Magnetverschluss klein ohne Gewinde

K198
bis 50 cm: 105,00 €

matte Holzjaspis-Perlen



Ø ca. 6 mm,
mit Magnetverschluss klein ohne Gewinde

K199
bis 50 cm: 97,00 €

matte Holzjaspis-Perlen



Ø ca. 8 mm,
mit Magnetverschluss klein ohne Gewinde

K200
bis 50 cm: 105,00 €

matte Sodalith-Perlen



Ø ca. 6 mm,
mit Magnetverschluss klein ohne Gewinde

K201
bis 50 cm: 97,00 €

matte Sodalith-Perlen

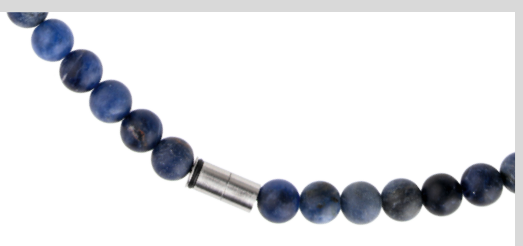

Ø ca. 8 mm,
mit Magnetverschluss klein ohne Gewinde

K202
bis 50 cm: 105,00 €

matt/gekratzt,
Spiegelankerkette Ø 1 mm,
(AN815/AK5)



Ø 6 mm, L: 42/45/50 cm,
mit Bajonett-Verschluss Ø 1,8 mm

K786
72,00 €

matt/polirt, Zirkonia white,
Spiegelankerkette Ø 1 mm,
(AN812.WH/AK5)



Ø ca. 7 mm, L: 42/45/50 cm,
mit Bajonett-Verschluss Ø 1,8 mm

K702
73,00 €

matt/polirt, Zirkonia white,
Spiegelankerkette Ø 1 mm,
(AN809.WH/AK5)



Ø 6 mm, L: 42/45/50 cm,
mit Bajonett-Verschluss Ø 1,8 mm

K785
72,00 €

polirt, Zirkonia white,
Spiegelankerkette Ø 1 mm,
(AN800.WH/AK5)



Ø 5 mm, L: 42/45/50 cm,
mit Bajonett-Verschluss Ø 1,8 mm

K782
85,50 €

polirt, Zirkonia white,
Spiegelankerkette Ø 2 mm,
(AN803.WH/AK6)



Ø 9 mm, L: 42/45/50 cm,
mit Bajonett-Verschluss Ø 1,8 mm

K783
92,00 €

polirt, Zirkonia white,
Spiegelankerkette Ø 2 mm,
(AN806.WH/AK6)



Ø 9 mm, L: 42/45/50 cm,
mit Bajonett-Verschluss Ø 1,8 mm

K784
101,50 €

matt/polirt, SW-Button-Perle
Ø ca. 5 mm,
Spiegelankerkette Ø 1 mm,
(AN833/AK5)



Ø 7 mm, L: 42/45/50 cm,
mit Bajonett-Verschluss Ø 1,8 mm

K788
72,00 €

matt/polirt/gekratzt,
Zirkonia white,
Spiegelankerkette Ø 1 mm,
(AN803.WH/AN815/AK5)



Ø ca. 9/6 mm, L: 42/45/50 cm,
mit Bajonett-Verschluss Ø 1,8 mm

K708
112,50 €

polirt,
Zirkonia white teilausgefasst,
Spiegelankerkette Ø 1,5 mm



Ø ca. 25 mm, L: 42/45/50 cm,
mit Clic-Verschluss Ø 2 mm

K790
129,00 €

polirt, Gelbgold beschichtet,
Zirkonia white teilausgefasst,
Spiegelankerkette Ø 1,5 mm



Ø ca. 25 mm, L: 42/45/50 cm,
mit Clic-Verschluss Ø 2 mm

K791
145,00 €

polirt, Roségold beschichtet,
Zirkonia white teilausgefasst,
Spiegelankerkette Ø 1,5 mm



Ø ca. 25 mm, L: 42/45/50 cm,
mit Clic-Verschluss Ø 2 mm

K792
145,00 €



matt/gekratzt/poliert,
Zirkonia white,
Schlangenkette Ø 1,8 mm,
(AN873/SC1.8/AN812.WH)



ca. 15x30 mm,
L: 42/45/50 cm,
mit Bajonett-Verschluss Ø 1,8 mm

K774
109,50 €

matt/gekratzt/
poliert, teilweise Gelbgold
beschichtet, Zirkonia white,
Drahtseil 2-fach,
(AN871/DS2.Bi/AN801.WH)



ca. 10x21 mm,
L: 42/45/50 cm,
mit Bajonett-Verschluss Ø 1,8 mm

K770
139,50 €

matt/poliert, Gelbgold beschichtet,
Zirkonia white, Spiegelankerkette
Ø 1 mm,
(AN810.WH/AK17)



Ø ca. 6 mm, L: 42/45/50 cm,
mit Bajonett-Verschluss Ø 1,6 mm

K701
95,00 €

matt/poliert, Gelbgold beschichtet,
SW-Button-Perle Ø ca. 6 mm,
Kugelmkette Ø 1,5 mm,
(AN837/AK26)



Ø ca. 9 mm, L: 42/45/50 cm,
mit Bajonett-Verschluss Ø 1,8 mm

K707
81,00 €

matt/poliert, Gelbgold beschichtet,
Zirkonia white, Spiegelankerkette Ø 1 mm,
(AN804.WH/AN810.WH/AK17)



Ø ca. 9/6 mm, L: 42/45/50 cm,
mit Bajonett-Verschluss Ø 1,6 mm

K714
138,00 €

poliert, Roségold beschichtet,
Zirkonia white, Spiegelankerkette Ø 2 mm,
(AN805.WH/AK20)



Ø ca. 9 mm, L: 42/45/50 cm,
mit Bajonett-Verschluss Ø 1,6 mm

K700
115,00 €

matt/poliert, teilweise Roségold
beschichtet, Zirkonia white,
SW-Button-Perle Ø ca. 5 mm,
Spiegelankerkette Ø 1 mm,
(AN805.WH/AN835/AK5)



Ø ca. 9/7 mm, L: 42/45/50 cm,
mit Bajonett-Verschluss Ø 1,8 mm

K720
127,00 €

matt/poliert/gekratzt,
teilweise Roségold
beschichtet, Zirkonia white,
Drahtseil 2-fach.
(AN862/AN811.WH/DS2.rot)



ca. 5x26 mm/Ø ca. 6 mm,
L: 42/45/50 cm,
mit Bajonett-Verschluss Ø 1,8 mm

K749
111,00 €



matt/poliert/gemustert
(A601, A602, E632, EH01,
Kettenstück+ANV16)



inkl. Verpackung



Länge Collier: ca. 50 cm,
Länge Armband: ca. 17-23 cm,
Länge Ohrschmuck: ca. 4 cm

S001
156,00 €

matt/poliert/gemustert, Kunstperlen
Ø ca. 8 mm (A603, A608, E632, EH01,
Kettenstück+ANV16)



inkl. Verpackung



Länge Collier: ca. 50 cm,
Länge Armband: ca. 17-23 cm,
Länge Ohrschmuck: ca. 4 cm

S002
182,00 €

matt/poliert/gemustert, Onyx- u. Spinell-Perlen
Ø ca. 6/5 mm (A605, A600, E632, EH02,
Kettenstück+ANV16)



inkl. Verpackung



Länge Collier: ca. 50 cm,
Länge Armband: ca. 17-23 cm,
Länge Ohrschmuck: ca. 5,5 cm

S003
182,00 €

matt/poliert/gemustert, teilweise Gelbgold
beschichtet (A608, A606, E632, EH03,
Kettenstück+ANV17)



inkl. Verpackung



Länge Collier: ca. 50 cm,
Länge Armband: ca. 17-23 cm,
Länge Ohrschmuck: ca. 5 cm

S004
166,00 €

matt/poliert/gemustert, teilweise Gelbgold
beschichtet, Kunstperlen Ø ca. 6 mm
(A604, A615, E633, EH04,
Kettenstück+ANV17)



inkl. Verpackung

Länge Collier: ca. 50 cm,
Länge Armband: ca. 17-23 cm,
Länge Ohrschmuck: ca. 4,5 cm

S005
212,00 €

matt/poliert/gemustert, teilweise Gelbgold
beschichtet, Onyx- u. Spinell-Perlen Ø ca. 6/5 mm
(A605, A607, E633, EH05,
Kettenstück+ANV17)



inkl. Verpackung

Länge Collier: ca. 50 cm,
Länge Armband: ca. 17-23 cm,
Länge Ohrschmuck: ca. 8 cm

S006
212,00 €

matt/poliert/gemustert, Gelbgold
beschichtet (A609, A611, E633, EH06,
Kettenstück+ANV17)



evia

inkl. Verpackung

Länge Collier: ca. 50 cm,
Länge Armband: ca. 17-23 cm,
Länge Ohrschmuck: ca. 4 cm

S007
196,00 €



poliert/gemustert



L: ca. 17-23 cm

A600
39,00 €

poliert/gemustert



L: ca. 17-23 cm

A601
39,00 €

poliert/gemustert



L: ca. 17-23 cm

A602
39,00 €

poliert/gemustert,
Kunstperlen Ø ca. 8 mm



L: ca. 17-23 cm

A603
65,00 €

poliert/gemustert,
Kunstperlen Ø ca. 6 mm



L: ca. 17-23 cm

A604
65,00 €

poliert/gemustert,
Onyx- und Spinell-Perlen
Ø ca. 6/5 mm



L: ca. 17-23 cm

A605
65,00 €

poliert/gemustert



L: ca. 17-23 cm

A606
39,00 €

poliert/gemustert,
Gelbgold beschichtet



L: ca. 17-23 cm

A607
49,00 €

poliert/gemustert



L: ca. 17-23 cm

A608
39,00 €

poliert/gemustert,
Gelbgold beschichtet



L: ca. 17-23 cm

A609
49,00 €

geriffelt/poliert/gemustert



L: ca. 17-23 cm

A610
39,00 €

geriffelt/poliert/gemustert,
Gelbgold beschichtet



L: ca. 17-23 cm

A611
49,00 €

geriffelt/poliert/gemustert



L: ca. 17-23 cm

A612
39,00 €

geriffelt/poliert/gemustert,
Gelbgold beschichtet



L: ca. 17-23 cm

A613
49,00 €

poliert/gemustert



L: ca. 17-23 cm

A614
39,00 €

poliert/gemustert,
Gelbgold beschichtet



L: ca. 17-23 cm

A615
49,00 €

geriffelt/poliert



Länge Eihänger
ca. 3 cm

EH01
10,00 €

poliert



Länge Eihänger
ca. 4,5 cm

EH02
10,00 €

poliert, Gelbgold
beschichtet



Länge Eihänger
ca. 4 cm

EH03
12,00 €

geriffelt/poliert,
Gelbgold
beschichtet



Länge Eihänger
ca. 3,5 cm

EH04
12,00 €

poliert, Gelbgold
beschichtet



Länge Eihänger
ca. 7 cm

EH05
12,00 €

geriffelt/poliert,
Gelbgold
beschichtet



Länge Eihänger
ca. 3 cm

EH06
12,00 €

gemustert/poliert



Ø ca. 19 mm

ANV16
19,00 €





gemustert/poliert,
Gelbgold
beschichtet



Ø ca. 19 mm

ANV17
22,00 €

<p>matt/polier, Brill. TW/SI 0,035 ct.</p>  <p>ca. 3x25 mm, Kettenöffnung 2 mm</p> <p>AN565 182,00 €</p>	<p>poliert, Brill. TW/SI 0,035 ct.</p>  <p>ca. 3x25 mm, Kettenöffnung 2 mm</p> <p>AN566 182,00 €</p>	<p>matt/polier, Brill. TW/SI 0,065 ct.</p>  <p>ca. 5x25 mm, Kettenöffnung 3 mm</p> <p>AN567 299,00 €</p>	<p>poliert, Brill. TW/SI 0,065 ct.</p>  <p>ca. 5x25 mm, Kettenöffnung 3 mm</p> <p>AN568 299,00 €</p>
<p>matt/polier, Brill. TW/SI 0,065 ct.</p>  <p>ca. 4x23 mm, Kettenöffnung 2,8 mm</p> <p>AN909 299,00 €</p>	<p>matt, Brill. TW/SI 0,016 ct.</p>  <p>Ø ca. 6 mm, Kettenöffnung 2,3 mm</p> <p>AN282 104,00 €</p>	<p>matt, Brill. TW/SI 0,035 ct.</p>  <p>Ø ca. 6 mm, Kettenöffnung 2,3 mm</p> <p>AN283 187,50 €</p>	<p>matt, Brill. TW/SI 0,065 ct.</p>  <p>Ø ca. 6 mm, Kettenöffnung 2,3 mm</p> <p>AN284 299,00 €</p>
<p>matt/polier, Brill. TW/SI 0,02 ct.</p>  <p>Ø ca. 12 mm, Kettenöffnung 2,7 mm</p> <p>AN860 139,50 €</p>	<p>matt/polier, Brill. TW/SI 0,035 ct.</p>  <p>Ø ca. 15 mm, Kettenöffnung 2,9 mm</p> <p>AN861 182,00 €</p>	<p>matt/polier/gekratzt, Brill. TW/SI 0,02 ct.</p>  <p>ca. 16x27 mm, Kettenöffnung 3 mm</p> <p>AN885 139,50 €</p>	<p>matt/polier/gekratzt, Brill. TW/SI 0,02 ct.</p>  <p>Ø ca. 20 mm, Kettenöffnung 3 mm</p> <p>AN889 146,00 €</p>
<p>matt/polier, Brill. TW/SI 0,02 ct.</p>  <p>ca. 7x20 mm, Kettenöffnung 2 mm</p> <p>AN900 139,50 €</p>	<p>matt/polier, Brill. TW/SI 0,02 ct.</p>  <p>ca. 8x19 mm, Kettenöffnung 2,1 mm</p> <p>AN990 135,00 €</p>	<p>matt/gekratzt, Brill. TW/SI 0,02 ct.</p>  <p>ca. 16x16 mm, Kettenöffnung 2 mm</p> <p>AN894 164,00 €</p>	<p>matt/gekratzt, Brill. TW/SI 0,02 ct.</p>  <p>ca. 8x8 mm, Kettenöffnung 2 mm</p> <p>AN897 130,00 €</p>
<p>matt/gekratzt/polier, Brill. TW/SI 0,02 ct.</p>  <p>ca. 14x17 mm, Kettenöffnung 2,1 mm</p> <p>AN937 176,00 €</p>	<p>matt/polier/gekratzt, Brill. TW/SI 0,02 ct.</p>  <p>Ø ca. 18 mm, Kettenöffnung 2,3 mm</p> <p>AN940 176,00 €</p>	<p>matt/polier/gekratzt, teilweise Gelbgold beschichtet, Brill. TW/SI 0,02 ct.</p>  <p>Ø ca. 18 mm, Kettenöffnung 2,3 mm</p> <p>AN941 196,50 €</p>	<p>matt/gekratzt, 585er Gelbgold, Brill. TW/SI 0,02 ct.</p>  <p>ca. 16x16 mm, Kettenöffnung 2 mm</p> <p>AN895 221,00 €</p>
<p>matt/gekratzt, 585er Gelbgold, Brill. TW/SI 0,02 ct.</p>  <p>ca. 8x8 mm, Kettenöffnung 2 mm</p> <p>AN898 185,00 €</p>	<p>matt/gekratzt/polier, teilweise Gelbgold beschichtet, Brill. TW/SI 0,02 ct.</p>  <p>ca. 14x17 mm, Kettenöffnung 2,1 mm</p> <p>AN938 196,50 €</p>	<p>matt/polier, 585er Gelbgold, Brill. TW/SI 0,02 ct.</p>  <p>Ø 10 mm, Kettenöffnung 2,3 mm</p> <p>AN846 176,00 €</p>	<p>matt/polier, 585er Gelbgold, Brill. TW/SI 0,02 ct.</p>  <p>Ø 10 mm, Kettenöffnung 2,8 mm</p> <p>AN850 196,50 €</p>

<p>matt/gekratzt, 585er Roségold, Brill. TW/SI 0,02 ct.</p>  <p>ca. 16x16 mm, Kettenöffnung 2 mm</p> <p>AN896 221,00 €</p>	<p>matt/gekratzt, 585er Roségold, Brill. TW/SI 0,02 ct.</p>  <p>ca. 8x8 mm, Kettenöffnung 2 mm</p> <p>AN899 185,00 €</p>	<p>matt/gekratzt/ poliert, teilweise Roségold beschichtet, Brill. TW/SI 0,02 ct.</p>  <p>ca. 14x17 mm, Kettenöffnung 2,1 mm</p> <p>AN939 196,50 €</p>	<p>matt/polirt, 585er Roségold, Brill. TW/SI 0,02 ct.</p>  <p>Ø 10 mm, Kettenöffnung 2,3 mm</p> <p>AN847 176,00 €</p>
<p>matt/polirt, 585er Roségold, Brill. TW/SI 0,02 ct.</p>  <p>Ø 10 mm, Kettenöffnung 2,8 mm</p> <p>AN851 196,50 €</p>	<p>matt/polirt, teilweise Schwarz beschichtet, Brill. TW/SI 0,02 ct.</p>  <p>Ø 10 mm, Kettenöffnung 2,3 mm</p> <p>AN843 134,00 €</p>	<p>matt/polirt, teilweise Schwarz beschichtet, Brill. TW/SI 0,02 ct.</p>  <p>Ø 10 mm, Kettenöffnung 2,8 mm</p> <p>AN845 134,00 €</p>	<p>matt/polirt/ gekratzt</p>  <p>ca. 16x27 mm, Kettenöffnung 3 mm</p> <p>AN884 66,00 €</p>
<p>matt/polirt/ gekratzt</p>  <p>Ø ca. 20 mm, Kettenöffnung 3 mm</p> <p>AN888 76,00 €</p>	<p>matt/polirt/ gekratzt</p>  <p>Ø ca. 40 mm, Kettenöffnung 3 mm</p> <p>AN891 104,00 €</p>	<p>matt/ polirt/ gekratzt</p>  <p>ca. 12x35 mm, Kettenöffnung Ø 5 mm</p> <p>AN942 79,00 €</p>	<p>matt/ gekratzt/ polirt</p>  <p>ca. 14x17 mm, Kettenöffnung 2,1 mm</p> <p>AN934 78,50 €</p>
<p>matt/polirt/ gekratzt</p>  <p>Ø ca. 12 mm, Kettenöffnung 2,3 mm</p> <p>AN944 49,00 €</p>	<p>matt/polirt/ gekratzt</p>  <p>Ø ca. 19 mm, Kettenöffnung 3,8 mm</p> <p>AN946 55,00 €</p>	<p>matt/gekratzt/ polirt</p>  <p>Ø ca. 26 mm, Kettenöffnung 4,5 mm</p> <p>AN948 65,00 €</p>	<p>matt/polirt</p>  <p>ca. 10x30 mm, Kettenöffnung 3 mm</p> <p>AN992 49,00 €</p>
<p>polirt/gekratzt/matt</p>  <p>ca. 50x55 mm, Kettenöffnung 5 mm</p> <p>AN994 104,00 €</p>	<p>matt/ polirt/ graviert</p>  <p>Ø ca. 12 mm, Kettenöffnung 2,8 mm</p> <p>AN852 30,50 €</p>	<p>matt/ polirt/ graviert</p>  <p>Ø ca. 26 mm, Kettenöffnung 5 mm</p> <p>AN562 78,50 €</p>	<p>matt/polirt/ gekratzt, teilweise Gelbgold beschichtet</p>  <p>ca. 16x27 mm, Kettenöffnung 3 mm</p> <p>AN886 73,00 €</p>
<p>matt/polirt/ gekratzt, teilweise Gelbgold beschichtet</p>  <p>ca. 12x35 mm, Kettenöffnung Ø 5 mm</p> <p>AN943 99,00 €</p>	<p>matt/gekratzt/ polirt, teilweise Gelbgold beschichtet</p>  <p>ca. 14x17 mm, Kettenöffnung 2,1 mm</p> <p>AN935 104,00 €</p>	<p>matt/polirt, teilweise Gelbgold beschichtet</p>  <p>Ø ca. 19 mm, Kettenöffnung 2,9 mm</p> <p>AN904 104,00 €</p>	<p>matt/polirt, teilweise Gelbgold beschichtet</p>  <p>Ø ca. 26 mm, Kettenöffnung 2,1 mm</p> <p>AN907 116,50 €</p>

matt/polirt/
gekratzt, teilweise
Gelbgold
beschichtet



Ø ca. 12 mm,
Kettenöffnung 2,3 mm

AN945
59,00 €

matt/polirt/
gekratzt, teilweise
Gelbgold
beschichtet



Ø ca. 19 mm,
Kettenöffnung 3,8 mm

AN947
69,00 €

matt/polirt/
gekratzt, teilweise
Gelbgold
beschichtet



Ø ca. 26 mm,
Kettenöffnung 4,5 mm

AN949
85,00 €

matt/gekratzt/polirt,
teilweise Gelbgold
beschichtet



ca. 50x55 mm,
Kettenöffnung 5 mm

AN995
125,00 €

matt/polirt,
Gelbgold
beschichtet



ca. 10x30 mm,
Kettenöffnung 3 mm

AN993
65,00 €

matt/polirt/
gekratzt,
teilweise Roségold
beschichtet



ca. 16x27 mm,
Kettenöffnung 3 mm

AN887
73,00 €

matt/gekratzt/
polirt, teilweise
Roségold beschichtet



ca. 14x17 mm,
Kettenöffnung 2,1 mm

AN936
104,00 €

matt/
polirt,
SW-Perle
Ø ca. 8 mm



ca. 17x29 mm,
Kettenöffnung 6 mm

AN134
134,00 €

matt/
polirt,
SW-Perle
Ø ca. 7 mm



Ø ca. 19 mm,
Kettenöffnung 4 mm

AN218
88,00 €

matt/polirt/
gekratzt,
SW-Perle
Ø ca. 5 mm



Ø ca. 17 mm,
Kettenöffnung 2,1 mm

AN950
69,00 €

matt/polirt/
gekratzt,
SW-Perle
Ø ca. 7 mm



Ø ca. 26 mm,
Kettenöffnung 3,5 mm

AN952
85,00 €

matt/polirt/
gekratzt,
SW-Perle
Ø ca. 7 mm



Ø ca. 26 mm,
Kettenöffnung 3,5 mm

AN954
129,00 €

geschliffen/
polirt, SW-
Button-Perle
Ø ca. 8 mm



H: ca. 17 mm,
Kettenöffnung 3,8 mm

AN420
56,00 €

geschliffen/
polirt, SW-
Button-Perle
Ø ca. 10 mm



H: ca. 20 mm,
Kettenöffnung 4,7 mm

AN423
78,50 €

matt/polirt,
SW-Button-
Perle Ø ca. 5 mm



ca. 13x24 mm,
Kettenöffnung 2,1 mm

AN901
95,00 €

matt/polirt,
SW-Button-
Perle Ø ca. 7 mm



ca. 20x39 mm,
Kettenöffnung 3,5 mm

AN902
116,50 €

polirt,
SW-Perle
Ø ca. 6 mm



ca. 7x28 mm,
Kettenöffnung 2,3 mm

AN991
79,00 €

matt/polirt/
gekratzt,
Gelbgold
beschichtet,
SW-Perle
Ø ca. 5 mm



Ø ca. 17 mm,
Kettenöffnung 2,1 mm

AN951
85,00 €

matt/polirt/
gekratzt,
Gelbgold
beschichtet,
SW-Perle
Ø ca. 7 mm



Ø ca. 26 mm,
Kettenöffnung 3,5 mm

AN953
99,00 €

matt/polirt/
gekratzt,
Gelbgold
beschichtet,
SW-Perle
Ø ca. 7 mm



Ø ca. 26 mm,
Kettenöffnung 3,5 mm

AN955
165,00 €

matt,
teilweise
Gelbgold
beschichtet,
SW-Perle
Ø ca. 8 mm



ca. 17x29 mm,
Kettenöffnung 6 mm

AN135
148,50 €

geschliffen/
polirt,
Gelbgold
beschichtet,
SW-Button-Perle
Ø ca. 8 mm



H: ca. 17 mm,
Kettenöffnung 3,8 mm

AN421
69,00 €

geschliffen/
polirt,
Gelbgold
beschichtet,
SW-Button-Perle
Ø ca. 10 mm



H: ca. 20 mm,
Kettenöffnung 4,7 mm

AN424
97,50 €

geschliffen/
poliert,
Roségold
beschichtet,
SW-Button-Perle
Ø ca. 8 mm

H: ca. 17 mm,
Kettenöffnung 3,8 mm

AN422
69,00 €

geschliffen/
poliert,
Roségold
beschichtet,
SW-Button-Perle
Ø ca. 10 mm

H: ca. 20 mm,
Kettenöffnung 4,7 mm

AN425
97,50 €

matt/poliert/
gekratzt

ca. 19x22 mm,
Kettenöffnung 2,3 mm

AN878
76,00 €

matt/poliert/
gekratzt

ca. 44x54 mm,
Kettenöffnung 2,3 mm

AN881
104,00 €

matt/gekratzt/poliert

ca. 9x13 mm,
Kettenöffnung 2,8 mm

AN276
45,00 €

matt/gekratzt/poliert

ca. 14x21 mm,
Kettenöffnung 3 mm

AN270
47,00 €

matt/gekratzt/
poliert

ca. 20x30 mm,
Kettenöffnung 3,5 mm

AN205
49,00 €

matt/gekratzt/
poliert

ca. 37x54 mm,
Kettenöffnung 6 mm

AN211
65,00 €

matt/
gekratzt/
poliert, Brill.
TW/SI 0,016 ct.

ca. 9x13 mm,
Kettenöffnung 2,8 mm

AN279
116,00 €

matt/
gekratzt/
poliert, Brill.
TW/SI 0,016 ct.

ca. 14x21 mm,
Kettenöffnung 3 mm

AN273
119,00 €

matt/gekratzt/
poliert, Brill.
TW/SI 0,02 ct.

ca. 20x30 mm,
Kettenöffnung 3,5 mm

AN226
149,00 €

matt/gekratzt/
poliert,
Brill. TW/SI
0,065 ct.

ca. 37x54 mm,
Kettenöffnung 6 mm

AN229
299,00 €

matt/gekratzt/
poliert, SW-
Button-Perle
Ø ca. 6 mm

ca. 20x30 mm,
Kettenöffnung 3,5 mm

AN208
65,00 €

matt/gekratzt/
poliert, SW-
Button-Perle
Ø ca. 8 mm

ca. 37x54 mm,
Kettenöffnung 6 mm

AN214
85,00 €

matt/poliert/
gekratzt,
teilweise
Gelbgold
beschichtet

ca. 19x22 mm,
Kettenöffnung 2,3 mm

AN879
86,50 €

matt/poliert/
gekratzt,
teilweise
Gelbgold
beschichtet

ca. 44x54 mm,
Kettenöffnung 2,3 mm

AN882
126,00 €

matt/gekratzt/poliert,
teilweise Gelbgold
beschichtet

ca. 9x13 mm,
Kettenöffnung 2,8 mm

AN277
62,00 €

matt/
gekratzt/
poliert, teilweise
Gelbgold
beschichtet

ca. 14x21 mm,
Kettenöffnung 3 mm

AN271
65,00 €

matt/gekratzt/
poliert, teilweise
Gelbgold
beschichtet

ca. 20x30 mm,
Kettenöffnung 3,5 mm

AN206
69,00 €

matt/gekratzt/
poliert,
teilweise
Gelbgold
beschichtet

ca. 37x54 mm,
Kettenöffnung 6 mm

AN212
99,00 €

matt/
gekratzt/
poliert, teilweise
Gelbgold
beschichtet, Brill.
TW/SI 0,016 ct.

ca. 9x13 mm,
Kettenöffnung 2,8 mm

AN280
133,00 €

matt/
gekratzt/
poliert, teilweise
Gelbgold
beschichtet, Brill.
TW/SI 0,016 ct.

ca. 14x21 mm,
Kettenöffnung 3 mm

AN274
137,00 €

matt/gekratzt/
poliert, teilweise
Gelbgold
beschichtet, Brill.
TW/SI 0,02 ct.

ca. 20x30 mm,
Kettenöffnung 3,5 mm

AN227
169,00 €

matt/gekratzt/
poliert,
teilweise
Gelbgold
beschichtet,
Brill. TW/SI
0,065 ct.

ca. 37x54 mm,
Kettenöffnung 6 mm

AN230
333,00 €

matt/gekratzt/
poliert, teilweise
Gelbgold
beschichtet,
SW-Button-Perle
Ø ca. 6 mm



ca. 20x30 mm,
Kettenöffnung 3,5 mm

AN209
85,00 €

matt/gekratzt/
poliert,
teilweise
Gelbgold
beschichtet,
SW-Button-
Perle Ø ca.
8 mm



ca. 37x54 mm,
Kettenöffnung 6 mm

AN215
119,00 €

matt/poliert/
gekratzt,
teilweise
Roségold
beschichtet



ca. 19x22 mm,
Kettenöffnung 2,3 mm

AN880
86,50 €

matt/poliert/
gekratzt,
teilweise
Roségold
beschichtet



ca. 44x54 mm,
Kettenöffnung 2,3 mm

AN883
126,00 €

matt/gekratzt/
poliert,
teilweise Roségold
beschichtet



ca. 9x13 mm,
Kettenöffnung 2,8 mm

AN278
62,00 €

matt/gekratzt/
poliert,
teilweise Roségold
beschichtet



ca. 14x21 mm,
Kettenöffnung 3 mm

AN272
65,00 €

matt/
gekratzt/
poliert, teilweise
Roségold
beschichtet



ca. 20x30 mm,
Kettenöffnung 3,5 mm

AN207
69,00 €

matt/gekratzt/
poliert,
teilweise
Roségold
beschichtet



ca. 37x54 mm,
Kettenöffnung 6 mm

AN213
99,00 €

matt/
gekratzt/
poliert, teilweise
Roségold
beschichtet, Brill.
TW/SI 0,016 ct.



ca. 9x13 mm,
Kettenöffnung 2,8 mm

AN281
133,00 €

matt/
gekratzt/
poliert, teilweise
Roségold
beschichtet, Brill.
TW/SI 0,016 ct.



ca. 14x21 mm,
Kettenöffnung 3 mm

AN275
137,00 €

matt/gekratzt/
poliert, teilweise
Roségold
beschichtet, Brill.
TW/SI 0,02 ct.



ca. 20x30 mm,
Kettenöffnung 3,5 mm

AN228
169,00 €

matt/gekratzt/
poliert,
teilweise
Roségold
beschichtet,
Brill. TW/SI
0,065 ct.



ca. 37x54 mm,
Kettenöffnung 6 mm

AN231
333,00 €

matt/gekratzt/
poliert, teilweise
Roségold
beschichtet,
SW-Button-Perle
Ø ca. 6 mm



ca. 20x30 mm,
Kettenöffnung 3,5 mm

AN210
85,00 €

matt/gekratzt/
poliert, teilweise
Roségold
beschichtet,
SW-Button-
Perle Ø ca.
8 mm



ca. 37x54 mm,
Kettenöffnung 6 mm

AN216
119,00 €

matt/
gekratzt/
poliert,
teilweise Altbronze
beschichtet



ca. 9x13 mm,
Kettenöffnung 2,8 mm

AN416
62,00 €

matt/
gekratzt/
poliert, teilweise
Altbronze
beschichtet



ca. 14x21 mm,
Kettenöffnung 3 mm

AN412
65,00 €

matt/
gekratzt/
poliert, teilweise
Altbronze
beschichtet



ca. 20x30 mm,
Kettenöffnung 3,5 mm

AN406
69,00 €

matt/gekratzt/
poliert,
teilweise
Altbronze
beschichtet



ca. 37x54 mm,
Kettenöffnung 6 mm

AN400
99,00 €

matt/
gekratzt/
poliert, teilweise
Altbronze
beschichtet, Brill.
TW/SI 0,016 ct.



ca. 14x21 mm,
Kettenöffnung 3 mm

AN414
137,00 €

matt/
gekratzt/
poliert, teilweise
Schwarz
beschichtet



ca. 9x13 mm,
Kettenöffnung 2,8 mm

AN417
62,00 €

matt/
gekratzt/
poliert, teilweise
Schwarz
beschichtet



ca. 14x21 mm,
Kettenöffnung 3 mm

AN413
65,00 €

matt/
gekratzt/
poliert, teilweise
Schwarz
beschichtet



ca. 20x30 mm,
Kettenöffnung 3,5 mm

AN407
69,00 €

matt/gekratzt/
poliert,
teilweise
Schwarz
beschichtet



ca. 37x54 mm,
Kettenöffnung 6 mm

AN401
99,00 €

matt/
gekratzt/
poliert, teilweise
Schwarz
beschichtet,
Brill. TW/SI
0,016 ct.



ca. 14x21 mm,
Kettenöffnung 3 mm

AN415
137,00 €

<p>matt/gekratzt</p>  <p>ca. 13x13 mm, Kettenöffnung 2 mm</p> <p>AN487 28,00 €</p>	<p>matt/gekratzt</p>  <p>ca. 9x13 mm, Kettenöffnung 2 mm</p> <p>AN490 28,00 €</p>	<p>matt/gekratzt</p>  <p>ca. 11x12 mm, Kettenöffnung 2 mm</p> <p>AN508 28,00 €</p>	<p>matt/gekratzt</p>  <p>ca. 13x13 mm, Kettenöffnung 2 mm</p> <p>AN514 28,00 €</p>
<p>geschliffen</p>  <p>Ø ca. 8 mm, Kettenöffnung 2 mm</p> <p>AN493 28,00 €</p>	<p>poliert/gekratzt</p>  <p>Ø ca. 20 mm, Kettenöffnung 2,9 mm</p> <p>AN957 48,00 €</p>	<p>poliert/gekratzt</p>  <p>Ø ca. 24 mm, Kettenöffnung 2,9 mm</p> <p>AN963 89,00 €</p>	<p>poliert/gekratzt/ matt</p>  <p>Ø ca. 17 mm, Kettenöffnung 2,1 mm</p> <p>AN972 55,00 €</p>
<p>poliert/gekratzt/ matt</p>  <p>Ø ca. 25 mm, Kettenöffnung 2,1 mm</p> <p>AN974 59,00 €</p>	<p>poliert, Zirkonia white</p>  <p>Ø ca. 11 mm, Kettenöffnung 2,8 mm</p> <p>AN544.WH 43,50 €</p>	<p>poliert, Zirkonia white</p>  <p>Ø ca. 11 mm, Kettenöffnung 2,8 mm</p> <p>AN547.WH 56,00 €</p>	<p>matt/poliert, Zirkonia white</p>  <p>ca. 7x12 mm, Kettenöffnung 5,5 mm</p> <p>AN910 95,00 €</p>
<p>matt/poliert, Zirkonia white</p>  <p>ca. 5x12 mm, Kettenöffnung 5,5 mm</p> <p>AN916 85,50 €</p>	<p>matt/poliert, Zirkonia white</p>  <p>ca. 8x12 mm, Kettenöffnung 5,5 mm</p> <p>AN922 116,50 €</p>	<p>matt/poliert, Zirkonia white</p>  <p>ca. 11x12 mm, Kettenöffnung 5,5 mm</p> <p>AN919 130,00 €</p>	<p>matt/poliert, Zirkonia white</p>  <p>ca. 7x12 mm, Kettenöffnung 5,5 mm</p> <p>AN913 69,00 €</p>
<p>poliert, Zirkonia white</p>  <p>ca. 6x12 mm, Kettenöffnung 5,5 mm</p> <p>AN925 95,00 €</p>	<p>poliert, Zirkonia white</p>  <p>ca. 6x12 mm, Kettenöffnung 5,5 mm</p> <p>AN928 95,00 €</p>	<p>poliert/gekratzt/ matt, Zirkonia white</p>  <p>Ø ca. 17 mm, Kettenöffnung 2,1 mm</p> <p>AN976 55,00 €</p>	<p>poliert/gekratzt/ matt, Zirkonia white</p>  <p>Ø ca. 25 mm, Kettenöffnung 2,1 mm</p> <p>AN978 59,00 €</p>
<p>poliert, Zirkonia white</p>  <p>ca. 2x24 mm, Kettenöffnung 2,4 mm</p> <p>AN931 46,50 €</p>	<p>poliert, Zirkonia white teilausgefasst</p>  <p>Ø ca. 35 mm, Kettenöffnung 2,8 mm</p> <p>AN966 85,00 €</p>	<p>poliert, Zirkonia white teilausgefasst</p>  <p>Ø ca. 49 mm, Kettenöffnung 3,6 mm</p> <p>AN969 99,00 €</p>	<p>poliert, Crystal White Pearl</p>  <p>Ø ca. 12 mm, Kettenöffnung 2 mm</p> <p>AN496.WHP 28,00 €</p>

poliert/gekratzt,
SW-Perle Ø
ca. 5 mm

Ø ca. 20 mm,
Kettenöffnung 2,9 mm

AN960
75,00 €

matt/gekratzt,
Gelbgold
beschichtet

ca. 13x13 mm,
Kettenöffnung 2 mm

AN488
35,00 €

matt/gekratzt,
Gelbgold
beschichtet

ca. 9x13 mm,
Kettenöffnung 2 mm

AN491
35,00 €

matt/gekratzt,
Gelbgold
beschichtet

ca. 11x12 mm,
Kettenöffnung 2 mm

AN509
35,00 €

matt/gekratzt,
Gelbgold
beschichtet

ca. 13x13 mm,
Kettenöffnung 2 mm

AN515
35,00 €

geschliffen,
Gelbgold
beschichtet

Ø ca. 8 mm,
Kettenöffnung 2 mm

AN494
35,00 €

poliert/gekratzt,
Gelbgold
beschichtet

Ø ca. 20 mm,
Kettenöffnung 2,9 mm

AN958
65,00 €

poliert/gekratzt,
teilweise Gelbgold
beschichtet

Ø ca. 24 mm,
Kettenöffnung 2,9 mm

AN964
105,00 €

poliert/gekratzt/
matt, Gelbgold
beschichtet

Ø ca. 17 mm,
Kettenöffnung 2,1 mm

AN973
69,00 €

poliert/gekratzt/
matt, Gelbgold
beschichtet

Ø ca. 25 mm,
Kettenöffnung 2,1 mm

AN975
75,00 €

poliert, Gelbgold
beschichtet, Zirkonia
white

Ø ca. 11 mm,
Kettenöffnung 2,8 mm

AN545.WH
53,50 €

poliert, Gelbgold
beschichtet, Zirkonia
white

Ø ca. 11 mm,
Kettenöffnung 2,8 mm

AN548.WH
66,00 €

matt/polirt,
Gelbgold
beschichtet,
Zirkonia white

ca. 7x12 mm,
Kettenöffnung 5,5 mm

AN911
120,50 €

matt/polirt,
Gelbgold
beschichtet,
Zirkonia white

ca. 5x12 mm,
Kettenöffnung 5,5 mm

AN917
97,50 €

matt/polirt,
Gelbgold
beschichtet,
Zirkonia white

ca. 8x12 mm,
Kettenöffnung 5,5 mm

AN923
130,00 €

matt/polirt,
Gelbgold
beschichtet,
Zirkonia white

ca. 11x12 mm,
Kettenöffnung 5,5 mm

AN920
137,00 €

matt/polirt,
Gelbgold
beschichtet,
Zirkonia white

ca. 7x12 mm,
Kettenöffnung 5,5 mm

AN914
78,50 €

poliert,
Gelbgold
beschichtet,
Zirkonia white

ca. 6x12 mm,
Kettenöffnung 5,5 mm

AN926
120,50 €

poliert,
Gelbgold
beschichtet,
Zirkonia white

ca. 6x12 mm,
Kettenöffnung 5,5 mm

AN929
120,50 €

poliert,
Gelbgold
beschichtet,
Zirkonia white

ca. 2x24 mm,
Kettenöffnung 2,4 mm

AN932
59,00 €

poliert/gekratzt/
matt, Gelbgold
beschichtet,
Zirkonia
white

Ø ca. 17 mm,
Kettenöffnung 2,1 mm

AN977
69,00 €

poliert/gekratzt/
matt, Gelbgold
beschichtet,
Zirkonia
white

Ø ca. 25 mm,
Kettenöffnung 2,1 mm

AN979
75,00 €

poliert, Gelbgold
beschichtet,
Zirkonia white
teilausgefasst

Ø ca. 35 mm,
Kettenöffnung 2,8 mm

AN967
99,00 €

poliert, Gelbgold
beschichtet,
Zirkonia white
teilausgefasst

Ø ca. 49 mm,
Kettenöffnung 3,6 mm

AN970
115,00 €

poliert, Gelbgold beschichtet, Crystal White Pearl



Ø ca. 12 mm, Kettenöffnung 2 mm

AN540.WHP 35,00 €

poliert/gekratzt, Gelbgold beschichtet, SW-Perle Ø ca. 5 mm



Ø ca. 20 mm, Kettenöffnung 2,9 mm

AN961 89,00 €

matt/gekratzt, Roségold beschichtet



ca. 13x13 mm, Kettenöffnung 2 mm

AN489 35,00 €

matt/gekratzt, Roségold beschichtet



ca. 9x13 mm, Kettenöffnung 2 mm

AN492 35,00 €

matt/gekratzt, Roségold beschichtet



ca. 11x12 mm, Kettenöffnung 2 mm

AN510 35,00 €

matt/gekratzt, Roségold beschichtet



ca. 13x13 mm, Kettenöffnung 2 mm

AN516 35,00 €

geschliffen, Roségold beschichtet



Ø ca. 8 mm, Kettenöffnung 2 mm

AN495 35,00 €

poliert/gekratzt, Roségold beschichtet



Ø ca. 20 mm, Kettenöffnung 2,9 mm

AN959 65,00 €

poliert/gekratzt, teilweise Roségold beschichtet



Ø ca. 24 mm, Kettenöffnung 2,9 mm

AN965 105,00 €

poliert, Roségold beschichtet, Zirkonia white



Ø ca. 11 mm, Kettenöffnung 2,8 mm

AN546.WH 53,50 €

poliert, Roségold beschichtet, Zirkonia white



Ø ca. 11 mm, Kettenöffnung 2,8 mm

AN549.WH 66,00 €

matt/polirt, Roségold beschichtet, Zirkonia white



ca. 7x12 mm, Kettenöffnung 5,5 mm

AN912 120,50 €

matt/polirt, Roségold beschichtet, Zirkonia white



ca. 5x12 mm, Kettenöffnung 5,5 mm

AN918 97,50 €

matt/polirt, Roségold beschichtet, Zirkonia white



ca. 8x12 mm, Kettenöffnung 5,5 mm

AN924 130,00 €

matt/polirt, Roségold beschichtet, Zirkonia white



ca. 11x12 mm, Kettenöffnung 5,5 mm

AN921 137,00 €

matt/polirt, Roségold beschichtet, Zirkonia white



ca. 7x12 mm, Kettenöffnung 5,5 mm

AN915 78,50 €

poliert, Roségold beschichtet, Zirkonia white



ca. 6x12 mm, Kettenöffnung 5,5 mm

AN927 120,50 €

poliert, Roségold beschichtet, Zirkonia white



ca. 6x12 mm, Kettenöffnung 5,5 mm

AN930 120,50 €

poliert, Roségold beschichtet, Zirkonia white



ca. 2x24 mm, Kettenöffnung 2,4 mm

AN933 59,00 €

poliert, Roségold beschichtet, Zirkonia white teilausgefasst



Ø ca. 35 mm, Kettenöffnung 2,8 mm

AN968 99,00 €

poliert, Roségold beschichtet, Zirkonia white teilausgefasst



Ø ca. 49 mm, Kettenöffnung 3,6 mm

AN971 115,00 €

poliert, Roségold beschichtet, Crystal White Pearl



Ø ca. 12 mm, Kettenöffnung 2 mm

AN541.WHP 35,00 €











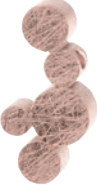

poliert/gekratzt, Roségold beschichtet, SW-Perle Ø ca. 5 mm



Ø ca. 20 mm, Kettenöffnung 2,9 mm

AN962 89,00 €

<p>matt/gekratzt</p>  <p>ca. 10x21 mm, Kettenöffnung 2 mm</p> <p>AN870 45,00 €</p>	<p>matt/gekratzt</p>  <p>ca. 10x30 mm, Kettenöffnung 2 mm</p> <p>AN873 48,00 €</p>	<p>matt/gekratzt</p>  <p>Ø 6 mm, Kettenöffnung 2 mm</p> <p>AN815 26,50 €</p>	<p>matt/gekratzt</p>  <p>Ø 8 mm, Kettenöffnung 2 mm</p> <p>AN818 28,00 €</p>
<p>matt/polirt/gekratzt</p>  <p>ca. 5x26 mm, Kettenöffnung 2 mm</p> <p>AN862 38,00 €</p>	<p>matt/polirt, Zirkonia white</p>  <p>Ø ca. 6 mm, Kettenöffnung 2 mm</p> <p>AN809.WH 26,50 €</p>	<p>matt/polirt, Zirkonia white</p>  <p>Ø ca. 7 mm, Kettenöffnung 2 mm</p> <p>AN812.WH 28,00 €</p>	<p>polirt, Zirkonia white</p>  <p>Ø ca. 5 mm, Kettenöffnung 2 mm</p> <p>AN800.WH 41,00 €</p>
<p>polirt, Zirkonia white</p>  <p>Ø ca. 9 mm, Kettenöffnung 2 mm</p> <p>AN806.WH 53,50 €</p>	<p>polirt, Zirkonia white</p>  <p>Ø ca. 9 mm, Kettenöffnung 2 mm</p> <p>AN803.WH 43,50 €</p>	<p>matt/polirt, SW-Button-Perle Ø ca. 5 mm</p>  <p>Ø ca. 7 mm, Kettenöffnung 2 mm</p> <p>AN833 26,50 €</p>	<p>matt/polirt, SW-Button-Perle Ø ca. 6 mm</p>  <p>Ø ca. 9 mm, Kettenöffnung 2 mm</p> <p>AN836 28,00 €</p>
<p>matt/gekratzt, Gelbgold beschichtet</p>  <p>ca. 10x21 mm, Kettenöffnung 2 mm</p> <p>AN871 57,50 €</p>	<p>matt/gekratzt, Gelbgold beschichtet</p>  <p>ca. 10x30 mm, Kettenöffnung 2 mm</p> <p>AN874 60,50 €</p>	<p>matt/gekratzt, Gelbgold beschichtet</p>  <p>Ø ca. 6 mm, Kettenöffnung 2 mm</p> <p>AN816 35,00 €</p>	<p>matt/gekratzt, Gelbgold beschichtet</p>  <p>Ø ca. 8 mm, Kettenöffnung 2 mm</p> <p>AN819 36,50 €</p>
<p>matt/polirt/gekratzt, Gelbgold beschichtet</p>  <p>ca. 5x26 mm, Kettenöffnung 2 mm</p> <p>AN863 45,00 €</p>	<p>matt/polirt, Zirkonia white, Gelbgold beschichtet</p>  <p>Ø ca. 6 mm, Kettenöffnung 2 mm</p> <p>AN810.WH 35,00 €</p>	<p>matt/polirt, Zirkonia white, Gelbgold beschichtet</p>  <p>Ø ca. 7 mm, Kettenöffnung 2 mm</p> <p>AN813.WH 36,50 €</p>	<p>polirt, Zirkonia white, Gelbgold beschichtet</p>  <p>Ø ca. 5 mm, Kettenöffnung 2 mm</p> <p>AN801.WH 48,00 €</p>
<p>polirt, Zirkonia white, Gelbgold beschichtet</p>  <p>Ø ca. 9 mm, Kettenöffnung 2 mm</p> <p>AN807.WH 60,50 €</p>	<p>polirt, Zirkonia white, Gelbgold beschichtet</p>  <p>Ø ca. 9 mm, Kettenöffnung 2 mm</p> <p>AN804.WH 50,50 €</p>	<p>matt/polirt, Gelbgold beschichtet, SW-Button-Perle Ø ca. 5 mm</p>  <p>Ø ca. 7 mm, Kettenöffnung 2 mm</p> <p>AN834 35,00 €</p>	<p>matt/polirt, Gelbgold beschichtet, SW-Button-Perle Ø ca. 6 mm</p>  <p>Ø ca. 9 mm, Kettenöffnung 2 mm</p> <p>AN837 36,50 €</p>

<p>matt/gekratzt, Roségold beschichtet</p>  <p>ca. 10x21 mm, Kettenöffnung 2 mm</p> <p>AN872 57,50 €</p>	<p>matt/gekratzt, Roségold beschichtet</p>  <p>ca. 10x30 mm, Kettenöffnung 2 mm</p> <p>AN875 60,50 €</p>	<p>matt/gekratzt, Roségold beschichtet</p>  <p>Ø ca. 6 mm, Kettenöffnung 2 mm</p> <p>AN817 35,00 €</p>	<p>matt/gekratzt, Roségold beschichtet</p>  <p>Ø ca. 8 mm, Kettenöffnung 2 mm</p> <p>AN820 36,50 €</p>
<p>matt/polier/gekratzt, Roségold beschichtet</p>  <p>ca. 5x26 mm, Kettenöffnung 2 mm</p> <p>AN864 45,00 €</p>	<p>matt/polier, Roségold beschichtet, Zirkonia white</p>  <p>Ø ca. 6 mm, Kettenöffnung 2 mm</p> <p>AN811.WH 35,00 €</p>	<p>matt/polier, Roségold beschichtet, Zirkonia white</p>  <p>Ø ca. 7 mm, Kettenöffnung 2 mm</p> <p>AN814.WH 36,50 €</p>	<p>poliert, Roségold beschichtet, Zirkonia white</p>  <p>Ø ca. 5 mm, Kettenöffnung 2 mm</p> <p>AN802.WH 48,00 €</p>
<p>poliert, Roségold beschichtet, Zirkonia white</p>  <p>Ø ca. 9 mm, Kettenöffnung 2 mm</p> <p>AN808.WH 60,50 €</p>	<p>poliert, Roségold beschichtet, Zirkonia white</p>  <p>Ø ca. 9 mm, Kettenöffnung 2 mm</p> <p>AN805.WH 50,50 €</p>	<p>matt/polier, Roségold beschichtet, SW-Button-Perle Ø ca. 5 mm</p>  <p>Ø ca. 7 mm, Kettenöffnung 2 mm</p> <p>AN835 35,00 €</p>	<p>matt/polier, Roségold beschichtet, SW-Button-Perle Ø ca. 6 mm</p>  <p>Ø ca. 9 mm, Kettenöffnung 2 mm</p> <p>AN838 36,50 €</p>



matt



B: ca. 16 mm,
WechselschlieÙe für
Magnetverschluss groß
mit Gewinde

AN237
35,00 €

matt



B: ca. 16 mm,
WechselschlieÙe für
Magnetverschluss groß
mit Gewinde

AN232
43,50 €

matt/poliert



B: ca. 16 mm,
WechselschlieÙe für
Magnetverschluss groß
mit Gewinde

AN165
43,50 €

geschliffen/
poliert



B: ca. 16 mm,
WechselschlieÙe für
Magnetverschluss groß
mit Gewinde

AN455
43,50 €

matt/Kautschuk



B: ca. 16 mm,
WechselschlieÙe für
Magnetverschluss groß
mit Gewinde

AN179
49,00 €

matt, Zirkonia
white



B: ca. 16 mm,
WechselschlieÙe für
Magnetverschluss groß
mit Gewinde

AN233.WH
95,00 €

matt, Zirkonia
black



B: ca. 16 mm,
WechselschlieÙe für
Magnetverschluss groß
mit Gewinde

AN233.BL
95,00 €

matt, Zirkonia
white



B: ca. 16 mm,
WechselschlieÙe für
Magnetverschluss groß
mit Gewinde

AN234.WH
69,00 €

matt, Zirkonia
black



B: ca. 16 mm,
WechselschlieÙe für
Magnetverschluss groß
mit Gewinde

AN234.BL
69,00 €

matt/poliert,
Zirkonia white



B: ca. 16 mm,
WechselschlieÙe für
Magnetverschluss groß
mit Gewinde

AN254
82,50 €

poliert, Zirkonia
white



B: ca. 16 mm,
WechselschlieÙe für
Magnetverschluss groß
mit Gewinde

AN537.WH
73,00 €

poliert, Zirkonia
black



B: ca. 16 mm,
WechselschlieÙe für
Magnetverschluss groß
mit Gewinde

AN537.BL
73,00 €

geschliffen/
poliert, Zirkonia
white



B: ca. 16 mm,
WechselschlieÙe für
Magnetverschluss groß
mit Gewinde

AN261
82,50 €

geschliffen,
Zirkonia white



B: ca. 16 mm,
WechselschlieÙe für
Magnetverschluss groß
mit Gewinde

AN430.WH
82,50 €

geschliffen,
Zirkonia black



B: ca. 16 mm,
WechselschlieÙe für
Magnetverschluss groß
mit Gewinde

AN430.BL
82,50 €

matt, teilweise
Gelbgold
beschichtet



B: ca. 16 mm,
WechselschlieÙe für
Magnetverschluss groß
mit Gewinde

AN166
56,00 €

matt/poliert,
teilweise
Gelbgold
beschichtet,
Zirkonia white



B: ca. 16 mm,
WechselschlieÙe für
Magnetverschluss groß
mit Gewinde

AN250
95,00 €

geschliffen/
poliert,
Gelbgold
beschichtet



B: ca. 16 mm,
WechselschlieÙe für
Magnetverschluss groß
mit Gewinde

AN456
56,00 €

matt, Gelbgold
beschichtet



B: ca. 16 mm,
WechselschlieÙe für
Magnetverschluss groß
mit Gewinde

AN240
66,00 €

matt, Gelbgold
beschichtet,
Zirkonia white



B: ca. 16 mm,
WechselschlieÙe für
Magnetverschluss groß
mit Gewinde

AN291.WH
116,50 €

matt, Gelbgold
beschichtet,
Zirkonia white



B: ca. 16 mm,
WechselschlieÙe für
Magnetverschluss groß
mit Gewinde

AN535.WH
78,50 €

geschliffen,
Gelbgold
beschichtet,
Zirkonia white



B: ca. 16 mm,
WechselschlieÙe für
Magnetverschluss groß
mit Gewinde

AN440.WH
95,00 €

matt, teilweise
Gelb- und
Roségold
beschichtet



B: ca. 16 mm,
WechselschlieÙe für
Magnetverschluss groß
mit Gewinde

AN256
70,50 €

matt/poliert,
teilweise
Roségold
beschichtet,
Zirkonia white



B: ca. 16 mm,
WechselschlieÙe für
Magnetverschluss groß
mit Gewinde

AN252
95,00 €

geschliffen/
poliert,
Roségold
beschichtet



B: ca. 16 mm,
Wechselschließe für
Magnetverschluss groß
mit Gewinde

AN457
56,00 €

matt, Roségold
beschichtet



B: ca. 16 mm,
Wechselschließe für
Magnetverschluss groß
mit Gewinde

AN241
66,00 €

matt, Roségold
beschichtet,
Zirkonia white



B: ca. 16 mm,
Wechselschließe für
Magnetverschluss groß
mit Gewinde

AN292.WH
116,50 €

matt, Roségold
beschichtet,
Zirkonia white



B: ca. 16 mm,
Wechselschließe für
Magnetverschluss groß
mit Gewinde

AN536.WH
78,50 €

geschliffen,
Roségold
beschichtet,
Zirkonia white



B: ca. 16 mm,
Wechselschließe für
Magnetverschluss groß
mit Gewinde

AN442.WH
95,00 €

geschliffen/poliert,
Schwarz
beschichtet



B: ca. 16 mm,
Wechselschließe für
Magnetverschluss groß
mit Gewinde

AN459
56,00 €

matt, Schwarz
beschichtet



B: ca. 16 mm,
Wechselschließe für
Magnetverschluss groß
mit Gewinde

AN295
66,00 €

matt, Schwarz
beschichtet,
Zirkonia white



B: ca. 16 mm,
Wechselschließe für
Magnetverschluss groß
mit Gewinde

AN296.WH
116,50 €

geschliffen,
Schwarz
beschichtet,
Zirkonia white



B: ca. 16 mm,
Wechselschließe für
Magnetverschluss groß
mit Gewinde

AN446.WH
95,00 €

geschliffen,
Schwarz
beschichtet,
Zirkonia black



B: ca. 16 mm,
Wechselschließe für
Magnetverschluss groß
mit Gewinde

AN446.BL
95,00 €

matt/geschliffen



Anhängerring
B: ca. 5 mm,
Ø ca. 28 mm

AN327
38,00 €

Aufsteckanhänger

SW-Perle
Ø ca. 8 mm



AN328
85,50 €

matt



Anhängerring B: ca. 2,5 mm,
Ø ca. 17/22/28/33 mm

AN300.1 20,50 € AN300.2 25,00 € AN300.3 28,00 € AN300.4 30,50 €

poliert



Anhängerring B: ca. 2,5 mm,
Ø ca. 17/22/28/33 mm

AN301.1 20,50 € AN301.2 25,00 € AN301.3 28,00 € AN301.4 30,50 €

matt,
Zirkonia white



Anhängerring B: ca. 2,5 mm,
Ø ca. 17/22/28/33 mm

AN307.1 70,50 € AN307.2 85,50 € AN307.3 101,50 € AN307.4 120,50 €

matt,
Zirkonia black



Anhängerring B: ca. 2,5 mm,
Ø ca. 17/22/28/33 mm

AN308.1 70,50 € AN308.2 85,50 € AN308.3 101,50 € AN308.4 120,50 €

matt,
Gelbgold beschichtet



Anhängerring B: ca. 2,5 mm,
Ø ca. 17/22/28/33 mm

AN302.1 38,00 € AN302.2 43,50 € AN302.3 49,00 € AN302.4 56,00 €

matt,
Roségold beschichtet

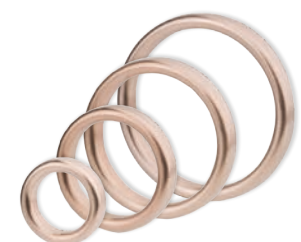

Anhängerring B: ca. 2,5 mm,
Ø ca. 17/22/28/33 mm

AN303.1 38,00 € AN303.2 43,50 € AN303.3 49,00 € AN303.4 56,00 €

Anhängerverschluss klein/groß

matt/polier



H: ca. 15/18 mm
Kettenöffnung 4,6 mm

ANV01 je 38,00 € ANV02 je 41,00 €

Anhängerverschluss groß

matt/polier, Zirkonia white/black



H: ca. 18 mm

ANV03.WH/.BL je 53,50 €

Anhängerverschluss klein/groß

matt/polier, Gelbgold beschichtet



H: ca. 15/18 mm

ANV04 je 43,50 € ANV05 je 46,50 €

Anhängerverschluss groß

matt/polier, Gelbgold beschichtet, Zirkonia white/black



H: ca. 18 mm

ANV06.WH/.BL je 59,00 €

Anhängerverschluss klein/groß

matt/polier, Roségold beschichtet



H: ca. 15/18 mm

ANV07 je 43,50 € ANV08 je 46,50 €

Anhängerverschluss groß

matt/polier, Roségold beschichtet, Zirkonia white/black



H: ca. 18 mm

ANV09.WH/.BL je 59,00 €

Aufsteckanhänger

matt, Farbstein Ø ca. 8 mm



AN329 je 30,50 €

	WH white		OL olive
	CH champagner		BR brown
	LP light pink		RE red
	AQ aquamarine		BL black
	LI lila		

AN329 ist in diesen neun Farben erhältlich.

silk wood braun



ca. 17x34 mm

AN700 25,00 €

silk wood braun



Ø ca. 28 mm

AN340.3 25,00 €

silk wood schwarz



ca. 17x34 mm

AN701 25,00 €

silk wood schwarz



Ø ca. 28 mm

AN702 25,00 €

Wechselschließe

matt/graviert



ca. 12x22 mm, für Magnetverschluss flach

AN703 43,50 €

Wechselschließe

matt/graviert



ca. 12x22 mm, für Magnetverschluss flach

AN704 43,50 €

Wechselschließe

matt/graviert



ca. 12x22 mm, für Magnetverschluss flach

AN705 43,50 €

Wechselschließe

matt/graviert



ca. 12x22 mm, für Magnetverschluss flach

AN706 43,50 €

Wechselschließe

matt/graviert



ca. 12x22 mm, für Magnetverschluss flach

AN708 43,50 €















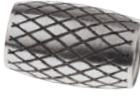



Wechselschließe

matt/graviert



ca. 12x22 mm, für Magnetverschluss flach

AN709 43,50 €

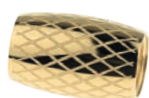
<p>poliert</p>  <p>B: ca. 14 mm, WechselschlieÙe für Magnetverschluss klein ohne Gewinde</p> <p>AN755 32,00 €</p>	<p>matt</p>  <p>B: ca. 14 mm, WechselschlieÙe für Magnetverschluss klein ohne Gewinde</p> <p>AN757 32,00 €</p>	<p>matt</p>  <p>B: ca. 14 mm, WechselschlieÙe klein für Magnetverschluss ohne Gewinde</p> <p>AN720 30,50 €</p>	<p>matt</p>  <p>B: ca. 14 mm, WechselschlieÙe für Magnetverschluss klein ohne Gewinde</p> <p>AN749 43,00 €</p>
<p>matt/poliert</p>  <p>B: ca. 14 mm, WechselschlieÙe klein für Magnetverschluss ohne Gewinde</p> <p>AN728 78,50 €</p>	<p>geschliffen</p>  <p>B: ca. 14 mm, WechselschlieÙe klein für Magnetverschluss ohne Gewinde</p> <p>AN724 38,00 €</p>	<p>matt/graviert</p>  <p>B: ca. 14 mm, WechselschlieÙe für Magnetverschluss klein ohne Gewinde</p> <p>AN752 43,00 €</p>	<p>matt/graviert</p>  <p>B: ca. 14 mm, WechselschlieÙe klein für Magnetverschluss ohne Gewinde</p> <p>AN743 43,50 €</p>
<p>matt/graviert</p>  <p>B: ca. 14 mm, WechselschlieÙe klein für Magnetverschluss ohne Gewinde</p> <p>AN744 43,50 €</p>	<p>matt/graviert</p>  <p>B: ca. 14 mm, WechselschlieÙe klein für Magnetverschluss ohne Gewinde</p> <p>AN745 43,50 €</p>	<p>matt/graviert</p>  <p>B: ca. 14 mm, WechselschlieÙe klein für Magnetverschluss ohne Gewinde</p> <p>AN746 43,50 €</p>	<p>matt/graviert</p>  <p>B: ca. 14 mm, WechselschlieÙe für Magnetverschluss klein ohne Gewinde</p> <p>AN747 43,50 €</p>
<p>antik-matt</p>  <p>B: ca. 14 mm, WechselschlieÙe für Magnetverschluss klein ohne Gewinde</p> <p>AN748 43,50 €</p>	<p>antik-matt</p>  <p>B: ca. 14 mm, WechselschlieÙe für Magnetverschluss klein ohne Gewinde</p> <p>AN750 43,00 €</p>	<p>matt/poliert, Zirkonia white</p>  <p>B: ca. 14 mm, WechselschlieÙe klein für Magnetverschluss ohne Gewinde</p> <p>AN732.WH 69,00 €</p>	<p>matt, Zirkonia white</p>  <p>B: ca. 14 mm, WechselschlieÙe klein für Magnetverschluss ohne Gewinde</p> <p>AN736.WH 88,00 €</p>
<p>poliert, Zirkonia white</p>  <p>B: ca. 14 mm, WechselschlieÙe klein für Magnetverschluss ohne Gewinde</p> <p>AN740.WH 146,00 €</p>	<p>poliert, Gelbgold beschichtet</p>  <p>B: ca. 14 mm, WechselschlieÙe für Magnetverschluss klein ohne Gewinde</p> <p>AN756 42,00 €</p>	<p>matt, Gelbgold beschichtet</p>  <p>B: ca. 14 mm, WechselschlieÙe für Magnetverschluss klein ohne Gewinde</p> <p>AN758 42,00 €</p>	<p>matt, Gelbgold beschichtet</p>  <p>B: ca. 14 mm, WechselschlieÙe klein für Magnetverschluss ohne Gewinde</p> <p>AN721 43,50 €</p>
<p>matt, Gelbgold beschichtet</p>  <p>B: ca. 14 mm, WechselschlieÙe für Magnetverschluss klein ohne Gewinde</p> <p>AN751 55,00 €</p>	<p>matt, teilweise Gelbgold beschichtet</p>  <p>B: ca. 14 mm, WechselschlieÙe klein für Magnetverschluss ohne Gewinde</p> <p>AN729 92,00 €</p>	<p>geschliffen, Gelbgold beschichtet</p>  <p>B: ca. 14 mm, WechselschlieÙe klein für Magnetverschluss ohne Gewinde</p> <p>AN725 49,00 €</p>	<p>poliert, Gelbgold beschichtet</p>  <p>B: ca. 14 mm, WechselschlieÙe für Magnetverschluss klein ohne Gewinde</p> <p>AN753 55,00 €</p>

matt/poliert,
teilweise
Gelbgold
beschichtet,
Zirkonia white



B: ca. 14 mm,
WechselschlieÙe klein
für Magnetverschluss
ohne Gewinde

AN733.WH
78,50 €

matt, Gelbgold
beschichtet,
Zirkonia white



B: ca. 14 mm,
WechselschlieÙe klein
für Magnetverschluss
ohne Gewinde

AN737.WH
111,00 €

poliert, teilweise
Gelbgold
beschichtet,
Zirkonia white



B: ca. 14 mm,
WechselschlieÙe klein
für Magnetverschluss
ohne Gewinde

AN741.WH
164,00 €

matt, Roségold
beschichtet



B: ca. 14 mm,
WechselschlieÙe klein
für Magnetverschluss
ohne Gewinde

AN722
43,50 €

matt, teilweise
Roségold
beschichtet



B: ca. 14 mm,
WechselschlieÙe klein
für Magnetverschluss
ohne Gewinde

AN730
92,00 €

geschliffen,
Roségold
beschichtet



B: ca. 14 mm,
WechselschlieÙe klein
für Magnetverschluss
ohne Gewinde

AN726
49,00 €

poliert, Roségold
beschichtet



B: ca. 14 mm,
WechselschlieÙe für
Magnetverschluss klein
ohne Gewinde

AN754
55,00 €

matt/poliert,
teilweise
Roségold
beschichtet,
Zirkonia white



B: ca. 14 mm,
WechselschlieÙe klein
für Magnetverschluss
ohne Gewinde

AN734.WH
78,50 €

matt, Roségold
beschichtet,
Zirkonia white



B: ca. 14 mm,
WechselschlieÙe klein
für Magnetverschluss
ohne Gewinde

AN738.WH
111,00 €

poliert, teilweise
Roségold
beschichtet,
Zirkonia white



B: ca. 14 mm,
WechselschlieÙe klein
für Magnetverschluss
ohne Gewinde

AN742.WH
164,00 €

matt, Schwarz
beschichtet



B: ca. 14 mm,
WechselschlieÙe klein
für Magnetverschluss
ohne Gewinde

AN723
43,50 €

geschliffen,
Schwarz
beschichtet



B: ca. 14 mm,
WechselschlieÙe klein
für Magnetverschluss
ohne Gewinde

AN727
49,00 €

matt, teilweise
Schwarz
beschichtet



B: ca. 14 mm,
WechselschlieÙe klein
für Magnetverschluss
ohne Gewinde

AN731
92,00 €

matt/poliert,
teilweise
Schwarz
beschichtet,
Zirkonia white



B: ca. 14 mm,
WechselschlieÙe klein
für Magnetverschluss
ohne Gewinde

AN735.WH
78,50 €

matt, Schwarz
beschichtet,
Zirkonia white



B: ca. 14 mm,
WechselschlieÙe klein
für Magnetverschluss
ohne Gewinde

AN739.WH
111,00 €

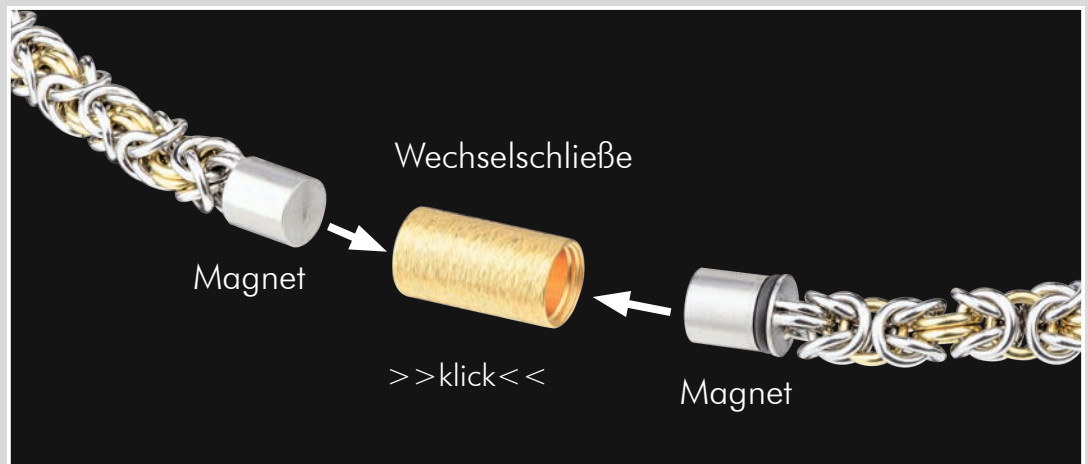

matt/polier, 2x
Brill. TW/SI 0,02 ct.



ca. 3x11 mm

E568
235,50 €

matt/polier, 2x
Brill. TW/SI 0,016 ct.



ca. 3x11 mm

E486
178,50 €

poliert, 2x
Brill. TW/SI 0,016 ct.



ca. 3x11 mm

E487
178,50 €

matt/polier, 2x
Brill. TW/SI 0,016 ct.



ca. 5x12 mm

E488
185,00 €

poliert, 2x
Brill. TW/SI 0,016 ct.



ca. 5x12 mm

E489
185,00 €

matt/polier, 2x
Brill. TW/SI 0,02 ct.



B: ca. 3 mm,
Ø ca. 13,5 mm

E490
285,00 €

poliert, 2x
Brill. TW/SI 0,02 ct.



B: ca. 3 mm,
Ø ca. 13,5 mm

E491
285,00 €

matt/polier, 2x
Brill. TW/SI 0,02 ct.



B: ca. 5 mm,
Ø ca. 13,5 mm

E492
294,00 €

poliert, 2x
Brill. TW/SI 0,02 ct.



B: ca. 5 mm,
Ø ca. 13,5 mm

E493
294,00 €

matt, 2x Brill. TW/SI
ca. 0,016 ct.



ca. 4x4 mm

E139
132,50 €

matt/polier,
2x Brill. TW/SI
0,02 ct.



ca. 1,5x13 mm

E512
233,00 €

matt/polier,
2x Brill. TW/SI
0,02 ct.



ca. 6x11 mm

E668
239,00 €

matt/polier,
2x Brill. TW/SI
0,02 ct.



je ca. 7x20 mm

E527
278,50 €

matt/gekratzt,
2x Brill. TW/SI
0,012 ct.



ca. 6x6 mm

E519
155,00 €

matt/polier,
2x Brill. TW/SI
0,02 ct.



Ø ca. 6 mm

E538
235,50 €

matt,
2x Brill. TW/SI
0,016 ct.



Ø ca. 7 mm

E539
176,00 €

matt/polier,
2x Brill. TW/SI
0,02 ct.



Ø ca. 7 mm

E534
235,50 €

matt, 2x Brill. TW/SI
0,02 ct.



Ø ca. 4 mm

E535
235,50 €

matt, 2x Brill. TW/SI
0,035 ct.



Ø ca. 5 mm

E536
294,00 €

matt, 2x Brill. TW/SI
0,065 ct.



Ø ca. 6 mm

E537
525,50 €

matt, 2x Brill. TW/SI
ca. 0,016 ct.



ca. 6x6 mm

E140
134,00 €

matt, 2x Brill. TW/SI
ca. 0,016 ct.



Ø ca. 4 mm

E272
187,50 €

matt, 2x Brill. TW/SI
ca. 0,035 ct.



Ø ca. 4 mm

E273
354,00 €

matt, 2x Brill. TW/SI
ca. 0,016 ct.



B: ca. 3 mm,
Ø ca. 12 mm

E113
195,00 €

matt, 2x Brill. TW/SI
ca. 0,016 ct.



B: ca. 3 mm,
Ø ca. 15 mm

E107
198,00 €

matt, 2x Brill. TW/SI
ca. 0,016 ct.



B: ca. 5 mm,
Ø ca. 12 mm

E115
200,50 €

matt, 2x Brill. TW/SI
ca. 0,016 ct.



B: ca. 5 mm,
Ø ca. 15 mm

E109
203,00 €

matt, 2x Brill. TW/SI
ca. 0,016 ct.



B: ca. 7 mm,
Ø ca. 12 mm

E117
204,50 €

matt, 2x Brill. TW/SI
ca. 0,016 ct.



B: ca. 7 mm,
Ø ca. 15 mm

E111
207,00 €

matt/poliert/gekratzt,
Brill. TW/SI
0,02 ct.



Ø ca. 9,5 mm

E594
278,50 €

matt/poliert,
2x Brill.
TW/SI 0,02 ct.,



ca. 6x14 mm

E609
239,00 €

matt/poliert/gekratzt,
2x Brill.
TW/SI 0,02 ct.,



Ø ca. 12 mm

E612
239,00 €

poliert, 2x Brill.
TW/SI 0,02 ct.,



ca. 5x16 mm

E614
235,00 €

matt/gekratzt,
585er Gelbgold,
2x Brill. TW/SI
0,012 ct.



ca. 6x6 mm

E520
235,50 €

matt/poliert,
585er Gelbgold,
2x Brill.
TW/SI 0,016 ct.



Ø 7 mm

E496
244,50 €

matt/poliert,
585er Gelbgold,
2x Brill.
TW/SI 0,016 ct.



Ø 10 mm

E498
299,00 €

matt/poliert/gekratzt,
teilweise Gelbgold
beschichtet,
Brill. TW/SI
0,02 ct.



Ø ca. 9,5 mm

E595
299,00 €

matt/gekratzt,
585er Roségold,
2x Brill. TW/SI
0,012 ct.



ca. 6x6 mm

E521
235,50 €

matt/poliert,
585er Roségold,
2x Brill.
TW/SI 0,016 ct.



Ø 7 mm

E497
244,50 €

matt/poliert,
585er Roségold,
2x Brill.
TW/SI 0,016 ct.



Ø 10 mm

E499
299,00 €

matt, Kautschuk,
2x Brill. TW/SI
ca. 0,016 ct.



ca. 6x6 mm

E162
150,00 €

matt, Kautschuk,
2x Brill. TW/SI
ca. 0,016 ct.



ca. 6x6 mm

E158
150,00 €

matt/poliert,
teilweise Schwarz
beschichtet,
2x Brill.
TW/SI 0,016 ct.



Ø 7 mm

E494
176,00 €

matt/poliert,
teilweise Schwarz
beschichtet,
2x Brill.
TW/SI 0,016 ct.



Ø 10 mm

E495
185,00 €

matt,
585er Gelbgold



H: ca. 9 mm

E75
95,00 €

matt



ca. 4x4 mm

E88
25,00 €

matt

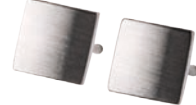

ca. 6x6 mm

E89
30,50 €

matt



H: ca. 12 mm

E20.S.O
28,00 €

<p>matt</p>  <p>B: ca. 3 mm, Ø ca. 12 mm</p> <p>E112 74,50 €</p>	<p>matt</p>  <p>B: ca. 3 mm, Ø ca. 15 mm</p> <p>E106 77,00 €</p>	<p>matt</p>  <p>B: ca. 5 mm, Ø ca. 12 mm</p> <p>E114 78,50 €</p>	<p>matt</p>  <p>B: ca. 5 mm, Ø ca. 15 mm</p> <p>E108 82,50 €</p>
<p>matt</p>  <p>B: ca. 7 mm, Ø ca. 12 mm</p> <p>E116 84,00 €</p>	<p>matt</p>  <p>B: ca. 7 mm, Ø ca. 15 mm</p> <p>E110 86,50 €</p>	<p>matt/poliert</p>  <p>H: ca. 9 mm</p> <p>E76 35,00 €</p>	<p>matt</p>  <p>H: ca. 12 mm</p> <p>E20.S 29,00 €</p>
<p>matt</p>  <p>Ø ca. 5 mm</p> <p>E171 30,50 €</p>	<p>matt</p>  <p>Ø ca. 6 mm</p> <p>E173 35,00 €</p>	<p>matt</p>  <p>Ø ca. 7 mm</p> <p>E175 38,00 €</p>	<p>matt</p>  <p>ca. 4x4 mm</p> <p>E84 28,00 €</p>
<p>matt</p>  <p>ca. 6x6 mm</p> <p>E85 35,00 €</p>	<p>matt, Kautschuk</p>  <p>ca. 6x6 mm</p> <p>E161 38,00 €</p>	<p>matt, Kautschuk</p>  <p>ca. 6x6 mm</p> <p>E157 38,00 €</p>	<p>matt/poliert/ gekratzt</p>  <p>ca. 7x13 mm</p> <p>E522 73,00 €</p>
<p>matt/ poliert</p>  <p>Ø ca. 30 mm</p> <p>E528 69,00 €</p>	<p>matt/ poliert</p>  <p>Ø ca. 49 mm</p> <p>E531 69,00 €</p>	<p>matt/poliert</p>  <p>ca. 3x26 mm</p> <p>E563 59,00 €</p>	<p>poliert</p>  <p>ca. 1,5x75 mm</p> <p>E613 65,00 €</p>
<p>matt/poliert/ gekratzt</p>  <p>Ø ca. 14 mm</p> <p>E525 116,50 €</p>	<p>matt/poliert/gekratzt</p>  <p>Ø ca. 9,5 mm</p> <p>E592 88,00 €</p>	<p>matt</p>  <p>Ø ca. 7 mm</p> <p>E275 49,00 €</p>	<p>matt</p>  <p>Ø ca. 10 mm</p> <p>E276 56,00 €</p>

matt/polier

E514
ca. 2x39 mm
69,00 €

matt/polier

E515
ca. 2x47 mm
78,50 €

poliert/gekratzt

E610
ca. 11x33 mm
79,00 €

gekratzt/polier/matt

E674
ca. 9x24 mm
109,00 €

matt/gekratzt/
polier

E615
Ø ca. 8 mm
65,00 €

matt/gekratzt/
polier

E617
Ø ca. 12 mm
69,00 €

matt/polier

E670
ca. 10x40 mm
85,00 €

polier/gekratzt/matt

E672
ca. 15x16 mm,
L: ca. 150 mm
111,00 €

matt/polier/graviert

E502
Ø ca. 8 mm
43,50 €

matt/polier/graviert

E503
Ø ca. 8 mm
43,50 €

matt/polier/graviert

E504
Ø ca. 8 mm
43,50 €

matt/polier,
2x SW-Button-
Perle Ø ca.
6 mm

E222
Ø ca. 10 mm
69,00 €

matt/polier,
2x SW-Perle
Ø ca. 4 mm

E250
Ø ca. 8 mm
78,50 €

matt, 2x SW-Perle
Ø ca. 6 mm

E148
L: ca. 21 mm
73,00 €

matt, 2x SW-Perle
Ø ca. 6 mm

E147
L: ca. 32 mm
76,00 €

matt/polier,
2x SW-Perle
Ø ca. 5 mm

E187
H: ca. 13 mm
69,00 €

geschliffen/polier,
2x SW-Perle
Ø ca. 6 mm

E311
ca. 4x15 mm
70,50 €

matt/polier,
SW-Button-
Perlen
Ø ca. 5 mm

E564
ca. 13x24 mm
164,00 €

matt,
SW-Perlen
Ø 4/5/6 mm

E596
ca. 2x28 mm
189,00 €

matt/polier,
2x SW-Perle
Ø ca. 4 mm

E208
B: ca. 6 mm,
Ø ca. 13 mm
134,00 €

matt/polier,
SW-Perlen
Ø ca. 3 mm



E561
ca. 1,5x13 mm
88,00 €

matt/polier,
SW-Perlen
Ø ca. 3,5 mm

E562
ca. 1,5x22 mm
92,00 €

polier,
SW-Perlen
Ø ca. 6 mm

E669
ca. 7x45 mm
139,00 €

<p>2x SW-Perle Ø ca. 3 mm</p>  <p>E143 20,50 €</p>	<p>2x SW-Perle Ø ca. 4 mm</p>  <p>E144 28,00 €</p>	<p>2x SW-Perle Ø ca. 5 mm</p>  <p>E145 41,00 €</p>	<p>2x SW-Perle Ø ca. 6 mm</p>  <p>E146 53,50 €</p>
<p>2x SW-Perle Ø ca. 7 mm</p>  <p>E247 78,50 €</p>	<p>2x SW-Perle Ø ca. 8 mm</p>  <p>E248 155,00 €</p>	<p>2x SW-Button-Perle Ø ca. 7 mm</p>  <p>E257 35,00 €</p>	<p>2x SW-Button-Perle Ø ca. 8 mm</p>  <p>E258 49,00 €</p>
<p>2x SW-Button-Perle Ø ca. 9 mm</p>  <p>E259 69,00 €</p>	<p>2x SW-Button-Perle Ø ca. 10 mm</p>  <p>E260 88,00 €</p>	<p>matt/polirt/ gekratzt, SW-Perlen Ø ca. 4 mm</p>  <p>Ø ca. 12 mm E619 89,00 €</p>	<p>matt/polirt/ gekratzt, SW-Perlen Ø ca. 5 mm</p>  <p>Ø ca. 17 mm E621 135,00 €</p>
<p>matt, teilweise Gelbgold beschichtet</p>  <p>H: ca. 12 mm E20.Bi 41,00 €</p>	<p>matt/polirt/gekratzt, teilweise Gelbgold beschichtet</p>  <p>Ø ca. 9,5 mm E593 104,00 €</p>	<p>matt, teilweise Gelbgold beschichtet</p>  <p>Ø ca. 7 mm E277 59,00 €</p>	<p>matt, teilweise Gelbgold beschichtet</p>  <p>Ø ca. 10 mm E278 70,50 €</p>
<p>matt/polirt/ gekratzt, teilweise Gelbgold beschichtet</p>  <p>ca. 7x13 mm E523 88,00 €</p>	<p>matt/polirt, teilweise Gelbgold beschichtet</p>  <p>Ø ca. 19 mm E566 176,00 €</p>	<p>polirt/gekratzt, Gelbgold beschichtet</p>  <p>ca. 11x33 mm E611 109,00 €</p>	<p>gekratzt/matt/ polirt, teilweise Gelbgold beschichtet</p>  <p>ca. 9x24 mm E675 135,00 €</p>
<p>matt/polirt/ gekratzt, teilweise Gelbgold beschichtet</p>  <p>Ø ca. 8 mm E616 79,00 €</p>	<p>matt/polirt/ gekratzt, teilweise Gelbgold beschichtet</p>  <p>Ø ca. 12 mm E618 95,00 €</p>	<p>matt/polirt, gekratzt, Gelbgold beschichtet</p>  <p>ca. 10x40 mm E671 99,00 €</p>	<p>matt/gekratzt/polirt, teilweise Gelbgold beschichtet</p>  <p>ca. 15x16 mm, L: ca. 150 mm E673 135,00 €</p>

matt/polirt/
gekratzt, teilweise
Roségold
beschichtet



ca. 7x13 mm

E524
88,00 €

matt, teilweise
Roségold
beschichtet



Ø ca. 7 mm

E279
59,00 €

matt, teilweise
Roségold
beschichtet



Ø ca. 10 mm

E280
70,50 €

matt, teilweise
Gelbgold
beschichtet,
2x SW-Perle
Ø ca. 6 mm



Ø ca. 10 mm

E223
82,50 €

matt, teilweise
Gelbgold
beschichtet,
2x SW-
Button-Perle
Ø ca. 4 mm



B: ca. 6 mm,
Ø ca. 13 mm

E209
155,00 €

matt, Gelbgold
beschichtet,
2x SW-Perle
Ø ca. 6 mm



H: ca. 21 mm

E150
88,00 €

matt, Gelbgold
beschichtet,
2x SW-Perle
Ø ca. 6 mm



H: ca. 32 mm

E149
92,00 €

matt/polirt/
gekratzt,
Gelbgold
beschichtet,
SW-Perlen
Ø ca. 4 mm



Ø ca. 12 mm

E620
109,00 €

matt/polirt/
gekratzt,
Gelbgold
beschichtet,
SW-Perlen
Ø ca. 5 mm



Ø ca. 17 mm

E622
159,00 €

geschliffen/polirt,
Gelbgold
beschichtet,
2x SW-Perle
Ø ca. 6 mm



ca. 4x15 mm

E312
95,00 €

geschliffen/polirt,
Roségold
beschichtet,
2x SW-Perle
Ø ca. 6 mm



ca. 4x15 mm

E313
95,00 €

matt, teilweise
Altbronze
beschichtet



Ø ca. 7 mm

E281
59,00 €

matt, teilweise
Altbronze
beschichtet



Ø ca. 10 mm

E282
70,50 €

matt, teilweise
Schwarz
beschichtet



Ø ca. 7 mm

E283
59,00 €





matt, teilweise
Schwarz
beschichtet



Ø ca. 10 mm

E284
70,50 €



<p>matt</p>  <p>Ø ca. 3 mm</p> <p>E183 25,00 €</p>	<p>matt</p>  <p>Ø ca. 4 mm</p> <p>E184 26,00 €</p>	<p>matt</p>  <p>Ø ca. 5 mm</p> <p>E185 27,00 €</p>	<p>matt</p>  <p>Ø ca. 6 mm</p> <p>E186 28,00 €</p>
<p>geschliffen</p>  <p>Ø ca. 3 mm</p> <p>E389 27,00 €</p>	<p>geschliffen</p>  <p>Ø ca. 4 mm</p> <p>E390 28,00 €</p>	<p>geschliffen</p>  <p>Ø ca. 5 mm</p> <p>E391 29,00 €</p>	<p>geschliffen</p>  <p>Ø ca. 6 mm</p> <p>E392 30,00 €</p>
<p>matt</p>  <p>ca. 3x3 mm</p> <p>E409 30,00 €</p>	<p>matt</p>  <p>ca. 4x4 mm</p> <p>E410 31,00 €</p>	<p>matt</p>  <p>ca. 5x5 mm</p> <p>E411 32,00 €</p>	<p>matt</p>  <p>ca. 6x6 mm</p> <p>E412 33,00 €</p>
<p>matt</p>  <p>ca. 3x3 mm</p> <p>E429 30,00 €</p>	<p>matt</p>  <p>ca. 4x4 mm</p> <p>E430 31,00 €</p>	<p>matt</p>  <p>ca. 5x5 mm</p> <p>E431 32,00 €</p>	<p>matt</p>  <p>ca. 6x6 mm</p> <p>E432 33,00 €</p>
<p>matt, teilweise Gelbgold beschichtet</p>  <p>Ø ca. 3 mm</p> <p>E285 32,00 €</p>	<p>matt, teilweise Gelbgold beschichtet</p>  <p>Ø ca. 4 mm</p> <p>E286 33,00 €</p>	<p>matt, teilweise Gelbgold beschichtet</p>  <p>Ø ca. 5 mm</p> <p>E287 34,00 €</p>	<p>matt, teilweise Gelbgold beschichtet</p>  <p>Ø ca. 6 mm</p> <p>E288 35,00 €</p>
<p>geschliffen, teilweise Gelbgold beschichtet</p>  <p>Ø ca. 3 mm</p> <p>E393 34,00 €</p>	<p>geschliffen, teilweise Gelbgold beschichtet</p>  <p>Ø ca. 4 mm</p> <p>E394 35,00 €</p>	<p>geschliffen, teilweise Gelbgold beschichtet</p>  <p>Ø ca. 5 mm</p> <p>E395 36,00 €</p>	<p>geschliffen, teilweise Gelbgold beschichtet</p>  <p>Ø ca. 6 mm</p> <p>E396 37,00 €</p>

matt, teilweise
Gelbgold beschichtet



ca. 3x3 mm
E413
37,00 €

matt, teilweise
Gelbgold beschichtet



ca. 4x4 mm
E414
38,00 €

matt, teilweise
Gelbgold beschichtet



ca. 5x5 mm
E415
39,00 €

matt, teilweise
Gelbgold beschichtet



ca. 6x6 mm
E416
40,00 €

matt, teilweise
Gelbgold beschichtet



ca. 3x3 mm
E433
37,00 €

matt, teilweise
Gelbgold beschichtet



ca. 4x4 mm
E434
38,00 €

matt, teilweise
Gelbgold beschichtet



ca. 5x5 mm
E435
39,00 €

matt, teilweise
Gelbgold beschichtet



ca. 6x6 mm
E436
40,00 €

matt, teilweise
Roségold beschichtet



Ø ca. 3 mm
E289
32,00 €

matt, teilweise
Roségold beschichtet

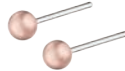

Ø ca. 4 mm
E290
33,00 €

matt, teilweise
Roségold beschichtet

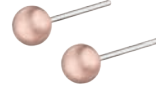

Ø ca. 5 mm
E291
34,00 €

matt, teilweise
Roségold beschichtet



Ø ca. 6 mm
E292
35,00 €

geschliffen, teilweise
Roségold beschichtet



Ø ca. 3 mm
E397
34,00 €

geschliffen, teilweise
Roségold beschichtet



Ø ca. 4 mm
E398
35,00 €

geschliffen, teilweise
Roségold beschichtet



Ø ca. 5 mm
E399
36,00 €

geschliffen, teilweise
Roségold beschichtet



Ø ca. 6 mm
E400
37,00 €

matt, teilweise
Roségold beschichtet



ca. 3x3 mm
E417
37,00 €

matt, teilweise
Roségold beschichtet



ca. 4x4 mm
E418
38,00 €

matt, teilweise
Roségold beschichtet



ca. 5x5 mm
E419
39,00 €

matt, teilweise
Roségold beschichtet



ca. 6x6 mm
E420
40,00 €

matt, teilweise
Roségold beschichtet



ca. 3x3 mm
E437
37,00 €

matt, teilweise
Roségold beschichtet



ca. 4x4 mm
E438
38,00 €

matt, teilweise
Roségold beschichtet























ca. 5x5 mm
E439
39,00 €

matt, teilweise
Roségold beschichtet



ca. 6x6 mm
E440
40,00 €

<p>matt, teilweise Altbronze beschichtet</p>  <p>Ø ca. 3 mm</p> <p>E293 32,00 €</p>	<p>matt, teilweise Altbronze beschichtet</p>  <p>Ø ca. 4 mm</p> <p>E294 33,00 €</p>	<p>matt, teilweise Altbronze beschichtet</p>  <p>Ø ca. 5 mm</p> <p>E295 34,00 €</p>	<p>matt, teilweise Altbronze beschichtet</p>  <p>Ø ca. 6 mm</p> <p>E296 35,00 €</p>
<p>geschliffen, teilweise Altbronze beschichtet</p>  <p>Ø ca. 3 mm</p> <p>E401 34,00 €</p>	<p>geschliffen, teilweise Altbronze beschichtet</p>  <p>Ø ca. 4 mm</p> <p>E402 35,00 €</p>	<p>geschliffen, teilweise Altbronze beschichtet</p>  <p>Ø ca. 5 mm</p> <p>E403 36,00 €</p>	<p>geschliffen, teilweise Altbronze beschichtet</p>  <p>Ø ca. 6 mm</p> <p>E404 37,00 €</p>
<p>matt, teilweise Altbronze beschichtet</p>  <p>ca. 3x3 mm</p> <p>E421 37,00 €</p>	<p>matt, teilweise Altbronze beschichtet</p>  <p>ca. 4x4 mm</p> <p>E422 38,00 €</p>	<p>matt, teilweise Altbronze beschichtet</p>  <p>ca. 5x5 mm</p> <p>E423 39,00 €</p>	<p>matt, teilweise Altbronze beschichtet</p>  <p>ca. 6x6 mm</p> <p>E424 40,00 €</p>
<p>matt, teilweise Altbronze beschichtet</p>  <p>ca. 3x3 mm</p> <p>E441 37,00 €</p>	<p>matt, teilweise Altbronze beschichtet</p>  <p>ca. 4x4 mm</p> <p>E442 38,00 €</p>	<p>matt, teilweise Altbronze beschichtet</p>  <p>ca. 5x5 mm</p> <p>E443 39,00 €</p>	<p>matt, teilweise Altbronze beschichtet</p>  <p>ca. 6x6 mm</p> <p>E444 40,00 €</p>
<p>matt, teilweise Schwarz beschichtet</p>  <p>Ø ca. 3 mm</p> <p>E297 32,00 €</p>	<p>matt, teilweise Schwarz beschichtet</p>  <p>Ø ca. 4 mm</p> <p>E298 33,00 €</p>	<p>matt, teilweise Schwarz beschichtet</p>  <p>Ø ca. 5 mm</p> <p>E299 34,00 €</p>	<p>matt, teilweise Schwarz beschichtet</p>  <p>Ø ca. 6 mm</p> <p>E300 35,00 €</p>
<p>geschliffen, teilweise Schwarz beschichtet</p>  <p>Ø ca. 3 mm</p> <p>E405 34,00 €</p>	<p>geschliffen, teilweise Schwarz beschichtet</p>  <p>Ø ca. 4 mm</p> <p>E406 35,00 €</p>	<p>geschliffen, teilweise Schwarz beschichtet</p>  <p>Ø ca. 5 mm</p> <p>E407 36,00 €</p>	<p>geschliffen, teilweise Schwarz beschichtet</p>  <p>Ø ca. 6 mm</p> <p>E408 37,00 €</p>

matt, teilweise
Schwarz beschichtet



ca. 3x3 mm
E425
37,00 €

matt, teilweise
Schwarz beschichtet



ca. 4x4 mm
E426
38,00 €

matt, teilweise
Schwarz beschichtet



ca. 5x5 mm
E427
39,00 €

matt, teilweise
Schwarz beschichtet



ca. 6x6 mm
E428
40,00 €

matt, teilweise
Schwarz beschichtet



ca. 3x3 mm
E445
37,00 €

matt, teilweise
Schwarz beschichtet



ca. 4x4 mm
E446
38,00 €

matt, teilweise
Schwarz beschichtet



ca. 5x5 mm
E447
39,00 €

matt, teilweise
Schwarz beschichtet



ca. 6x6 mm
E448
40,00 €

matt, Farbstein
Ø 4 mm



Ø ca. 5 mm
E200
30,50 €

matt, Farbstein
Ø 5 mm



Ø ca. 6 mm
E201
35,00 €

	WH white		OL olive
	CH champagner		BR brown
	LP light pink		RE red
	AQ aquamarine		BL black
	LI lila		

Farbsteinohrstecker sind
in diesen neun Farben erhältlich.

matt/gekratzt/poliert,
2x Brill. TW/SI
0,016 ct.



ca. 9x13 mm
E264
169 €

matt/gekratzt/
poliert,
2x Brill. TW/SI
0,016 ct.



ca. 14x50 mm
E261
189,00 €

matt/gekratzt/poliert,
teilweise Gelbgold
beschichtet, 2x Brill.
TW/SI 0,016 ct.



ca. 9x13 mm
E265
189,00 €

matt/gekratzt/
poliert, teilweise
Gelbgold
beschichtet,
2x Brill.
TW/SI
0,016 ct.



ca. 14x50 mm
E262
215,00 €

matt/gekratzt/poliert,
teilweise Roségold
beschichtet. 2x Brill.
TW/SI 0,016 ct.



ca. 9x13 mm
E266
189,00 €

matt/gekratzt/
poliert, teilweise
Roségold
beschichtet,
2x Brill.
TW/SI
0,016 ct.



ca. 14x50 mm
E263
215,00 €

matt/gekratzt/polier



ca. 9x13 mm
E244
59,00 €

matt/gekratzt/
poliert



ca. 14x50 mm
E241
73,00 €

matt/polier/gekratzt



ca. 10x12 mm
E555
95,00 €

matt/polier/
gekratzt



ca. 19x22 mm
E558
146,00 €

matt/gekratzt/
poliert



ca. 10x12 mm,
L: ca. 120 mm
E589
111,00 €

matt/gekratzt/poliert,
teilweise Gelbgold
beschichtet



ca. 9x13 mm
E245
79,00 €

matt/gekratzt/
poliert, teilweise
Gelbgold
beschichtet



ca. 14x50 mm
E242
99,00 €

matt/polier/gekratzt,
teilweise
Gelbgold
beschichtet



ca. 10x12 mm
E556
116,50 €

matt/polier/
gekratzt, teilweise
Gelbgold
beschichtet



ca. 19x22 mm
E559
166,50 €

matt/gekratzt/
poliert, teilweise
Gelbgold
beschichtet



ca. 10x12 mm,
L: ca. 120 mm
E590
135,00 €

matt/gekratzt/poliert,
teilweise Roségold
beschichtet



ca. 9x13 mm
E246
79,00 €

matt/gekratzt/
poliert, teilweise
Roségold
beschichtet



ca. 14x50 mm
E243
99,00 €

matt/polier/gekratzt,
teilweise
Roségold
beschichtet



ca. 10x12 mm
E557
116,50 €

matt/polier/
gekratzt, teilweise
Roségold
beschichtet



ca. 19x22 mm
E560
166,50 €

matt/gekratzt/
poliert, teilweise
Roségold
beschichtet



ca. 10x12 mm,
L: ca. 120 mm
E591
135,00 €

matt/gekratzt/
poliert,
teilweise Altbronze
beschichtet



ca. 9x13 mm
E305
79,00 €

matt/gekratzt/
poliert, teilweise
Altbronze
beschichtet



ca. 14x50 mm
E301
99,00 €

matt/gekratzt/
poliert, teilweise
Schwarz
beschichtet



ca. 9x13 mm
E306
79,00 €

matt/gekratzt/
poliert, teilweise
Schwarz
beschichtet



ca. 14x50 mm
E302
99,00 €



matt/gekratzt

E467
Ø ca. 7 mm
43,50 €

matt/gekratzt

E516
ca. 10x21 mm
57,50 €

matt/gekratzt

- Stift mittig -

E540
ca. 10x21 mm
57,50 €

poliert/gekratzt

edia

E623
Ø ca. 20 mm
89,00 €

poliert/gekratzt

edia

E626
Ø ca. 20 mm
89,00 €

geschliffen/poliert

E326
Ø ca. 12 mm
59,00 €

poliert,
Zirkonia white

E569
ca. 2x19 mm
78,50 €

poliert,
Zirkonia white
teilausgefasst

edia

E629
Ø ca. 25 mm
149,00 €

matt/poliert,
Zirkonia white

E458.WH
Ø ca. 3 mm
41,00 €

matt/poliert,
Zirkonia white

E461.WH
Ø ca. 4 mm
43,50 €

matt/poliert,
Zirkonia white

E464.WH
Ø ca. 5 mm
46,50 €

poliert, Zirkonia white

E455.WH
Ø ca. 6 mm
69,00 €

poliert, Zirkonia white

E452.WH
Ø ca. 9 mm
88,00 €

poliert, Zirkonia white

E449.WH
Ø ca. 9 mm
76,00 €

poliert,
2x SW-Button-Perle
Ø ca. 5 mm

E476
Ø ca. 6 mm
43,50 €

poliert,
2x SW-Button-Perle
Ø ca. 6 mm

E479
Ø ca. 7 mm
46,50 €

poliert,
2x Crystal
White Pearl

E329.WHP
Ø ca. 12 mm
59,00 €

matt/gekratzt,
Gelbgold beschichtet

E468
Ø ca. 7 mm
56,00 €

matt/gekratzt,
Gelbgold
beschichtet

E517
ca. 10x21 mm
74,50 €

matt/gekratzt,
Gelbgold
beschichtet

- Stift mittig -

E541
ca. 10x21 mm
74,50 €

poliert/gekratzt,
Gelbgold
beschichtet

edia

E624
Ø ca. 20 mm
119,00 €

poliert/gekratzt,
Gelbgold
beschichtet

edia

E627
Ø ca. 20 mm
119,00 €

geschliffen/poliert,
Gelbgold
beschichtet

E327
Ø ca. 12 mm
70,50 €

poliert,
Gelbgold
beschichtet,
Zirkonia white

E570
ca. 2x19 mm
104,00 €

poliert, Gelbgold beschichtet, Zirkonia white teil- ausge- fasst



evia

E630
Ø ca. 25 mm 179,00 €

matt/poliert, Gelbgold beschichtet, Zirkonia white



E459.WH
Ø ca. 3 mm 53,50 €

matt/poliert, Gelbgold beschichtet, Zirkonia white



E462.WH
Ø ca. 4 mm 56,00 €

matt/poliert, Gelbgold beschichtet, Zirkonia white



E465.WH
Ø ca. 5 mm 59,00 €

poliert, teilweise Gelbgold beschichtet, Zirkonia white



E456.WH
Ø ca. 6 mm 82,50 €

poliert, teilweise Gelbgold beschichtet, Zirkonia white



E453.WH
Ø ca. 9 mm 104,00 €

poliert, teilweise Gelbgold beschichtet, Zirkonia white



E450.WH
Ø ca. 9 mm 92,00 €

poliert, Gelbgold beschichtet, 2x Crystal White Pearl



E385.WHP
Ø ca. 12 mm 69,00 €

matt/poliert, Gelbgold beschichtet, 2x SW-Button-Perle
Ø ca. 5 mm



E477
Ø ca. 6 mm 56,00 €

matt/poliert, Gelbgold beschichtet, 2x SW-Button-Perle
Ø ca. 6 mm



E480
Ø ca. 7 mm 59,00 €

poliert/gekratzt, Roségold beschichtet



evia

E625
Ø ca. 20 mm 119,00 €

poliert/gekratzt, Roségold beschichtet



evia

E628
Ø ca. 20 mm 119,00 €

matt/gekratzt, Roségold beschichtet



E518
ca. 10x21 mm 74,50 €

matt/gekratzt, Roségold beschichtet



- Stift mittig -

E542
ca. 10x21 mm 74,50 €

matt/gekratzt, Roségold beschichtet



E469
Ø ca. 7 mm 56,00 €

geschliffen/poliert, Roségold beschichtet



E328
Ø ca. 12 mm 70,50 €

poliert, Roségold beschichtet, Zirkonia white



E571
ca. 2x19 mm 104,00 €

poliert, Roségold beschichtet, Zirkonia white teil- ausge- fasst



evia

E631
Ø ca. 25 mm 179,00 €

matt/poliert, Roségold beschichtet, Zirkonia white



E460.WH
Ø ca. 3 mm 53,50 €

matt/poliert, Roségold beschichtet, Zirkonia white



E463.WH
Ø ca. 4 mm 56,00 €

matt/poliert, Roségold beschichtet, Zirkonia white



E466.WH
Ø ca. 5 mm 59,00 €

poliert, teilweise Roségold beschichtet, Zirkonia white



E457.WH
Ø ca. 6 mm 82,50 €

poliert, teilweise Roségold beschichtet, Zirkonia white



E454.WH
Ø ca. 9 mm 104,00 €

poliert, teilweise Roségold beschichtet, Zirkonia white



E451.WH
Ø ca. 9 mm 92,00 €

poliert,
Roségold
beschichtet,
2x Crystal
White Pearl



E386.WHP
69,00 €

Ø ca. 12 mm

poliert, Roségold
beschichtet, 2x SW-Button-Perle
Ø ca. 5 mm



E478
56,00 €

Ø ca. 6 mm

poliert, Roségold
beschichtet, 2x SW-Button-Perle
Ø ca. 6 mm



E481
59,00 €

Ø ca. 7 mm

matt/polier



E575
66,00 €

Ø ca. 14 mm,
B: ca. 4 mm

matt/polier



E579
69,00 €

Ø ca. 14 mm,
B: ca. 6 mm

poliert



E576
66,00 €

Ø ca. 14 mm,
B: ca. 4 mm

poliert



E580
69,00 €

Ø ca. 14 mm,
B: ca. 6 mm

matt/polier



E583
116,50 €

Ø ca. 14 mm,
B: ca. 4 mm

matt/polier



E586
113,50 €

Ø ca. 14 mm,
B: ca. 6 mm

poliert



E572
88,00 €

Ø ca. 14 mm,
B: ca. 2 mm

matt/polier



E577
85,50 €

Ø ca. 14 mm,
B: ca. 4 mm

matt/polier



E581
88,00 €

Ø ca. 14 mm,
B: ca. 6 mm

matt/polier



E584
134,00 €

Ø ca. 14 mm,
B: ca. 4 mm

matt/polier



E587
135,00 €

Ø ca. 14 mm,
B: ca. 6 mm

poliert



E573
111,00 €

Ø ca. 14 mm,
B: ca. 2 mm

matt/polier



E578
85,50 €

Ø ca. 14 mm,
B: ca. 4 mm

matt/polier



E582
88,00 €

Ø ca. 14 mm,
B: ca. 6 mm

matt/polier



E585
134,00 €

Ø ca. 14 mm,
B: ca. 4 mm

matt/polier



E588
135,00 €

























Ø ca. 14 mm,
B: ca. 6 mm

poliert



E574
111,00 €

Ø ca. 14 mm,
B: ca. 2 mm

<p>poliert</p>  <p>Ø ca. 14 mm, B: ca. 2 mm</p> <p>E597 69,00 €</p>	<p>poliert</p>  <p>Ø ca. 14 mm, B: ca. 4 mm</p> <p>E603 75,00 €</p>	<p>poliert, Zirkonia white teilausgefasst</p>  <p>Ø ca. 14 mm, B: ca. 2 mm</p> <p>E600 85,00 €</p>	<p>poliert, Zirkonia white teilausgefasst</p>  <p>Ø ca. 14 mm, B: ca. 4 mm</p> <p>E606 95,00 €</p>
<p>poliert, Gelbgold beschichtet</p>  <p>Ø ca. 14 mm, B: ca. 2 mm</p> <p>E598 89,00 €</p>	<p>poliert, Gelbgold beschichtet</p>  <p>Ø ca. 14 mm, B: ca. 4 mm</p> <p>E604 95,00 €</p>	<p>poliert, Gelbgold beschichtet, Zirkonia white teilausgefasst</p>  <p>Ø ca. 14 mm, B: ca. 2 mm</p> <p>E601 105,00 €</p>	<p>poliert, Gelbgold beschichtet, Zirkonia white teilausgefasst</p>  <p>Ø ca. 14 mm, B: ca. 4 mm</p> <p>E607 115,00 €</p>
<p>poliert, Roségold beschichtet</p>  <p>Ø ca. 14 mm, B: ca. 2 mm</p> <p>E599 89,00 €</p>	<p>poliert, Roségold beschichtet</p>  <p>Ø ca. 14 mm, B: ca. 4 mm</p> <p>E605 95,00 €</p>	<p>poliert, Roségold beschichtet, Zirkonia white teilausgefasst</p>  <p>Ø ca. 14 mm, B: ca. 2 mm</p> <p>E602 105,00 €</p>	<p>poliert, Roségold beschichtet, Zirkonia white teilausgefasst</p>  <p>Ø ca. 14 mm, B: ca. 4 mm</p> <p>E608 115,00 €</p>
<p>poliert</p>  <p>Ø ca. 34 mm, B: ca. 2 mm</p> <p>E543 69,00 €</p>	<p>poliert</p>  <p>Ø ca. 49 mm, B: ca. 2 mm</p> <p>E546 78,50 €</p>	<p>poliert, Zirkonia white teilausgefasst</p>  <p>Ø ca. 34 mm, B: ca. 2 mm</p> <p>E549 95,00 €</p>	<p>poliert, Zirkonia white teil- ausgefasst</p>  <p>Ø ca. 49 mm, B: ca. 2 mm</p> <p>E552 104,00 €</p>
<p>poliert, Gelbgold beschichtet</p>  <p>Ø ca. 34 mm, B: ca. 2 mm</p> <p>E544 97,50 €</p>	<p>poliert, Gelbgold beschichtet</p>  <p>Ø ca. 49 mm, B: ca. 2 mm</p> <p>E547 111,00 €</p>	<p>poliert, Gelbgold beschichtet, Zirkonia white teilausgefasst</p>  <p>Ø ca. 34 mm, B: ca. 2 mm</p> <p>E550 123,00 €</p>	<p>poliert, Gelbgold beschichtet, Zirkonia white teil- ausgefasst</p>  <p>Ø ca. 49 mm, B: ca. 2 mm</p> <p>E553 132,50 €</p>
<p>poliert, Roségold beschichtet</p>  <p>Ø ca. 34 mm, B: ca. 2 mm</p> <p>E545 97,50 €</p>	<p>poliert, Roségold beschichtet</p>  <p>Ø ca. 49 mm, B: ca. 2 mm</p> <p>E548 111,00 €</p>	<p>poliert, Roségold beschichtet, Zirkonia white teilausgefasst</p>  <p>Ø ca. 34 mm, B: ca. 2 mm</p> <p>E551 123,00 €</p>	<p>poliert, Roségold beschichtet, Zirkonia white teil- ausgefasst</p>  <p>Ø ca. 49 mm, B: ca. 2 mm</p> <p>E554 132,50 €</p>

<p>poliert</p>  <p><i>edia</i></p> <p>B: ca. 3 mm, Ø ca. 12 mm</p> <p>E632 39,00 €</p>	<p>poliert</p>  <p><i>edia</i></p> <p>B: ca. 5 mm, Ø ca. 12 mm</p> <p>E638 42,00 €</p>	<p>poliert</p>  <p><i>edia</i></p> <p>B: ca. 7 mm, Ø ca. 12 mm</p> <p>E644 45,00 €</p>
<p>poliert</p>  <p><i>edia</i></p> <p>B: ca. 3 mm, Ø ca. 16 mm</p> <p>E650 45,00 €</p>	<p>poliert</p>  <p><i>edia</i></p> <p>B: ca. 5 mm, Ø ca. 16 mm</p> <p>E656 48,00 €</p>	<p>poliert</p>  <p><i>edia</i></p> <p>B: ca. 7 mm, Ø ca. 16 mm</p> <p>E662 51,00 €</p>
<p>matt/poliert</p>  <p><i>edia</i></p> <p>B: ca. 3 mm, Ø ca. 12 mm</p> <p>E634 39,00 €</p>	<p>matt/poliert</p>  <p><i>edia</i></p> <p>B: ca. 5 mm, Ø ca. 12 mm</p> <p>E640 42,00 €</p>	<p>matt/poliert</p>  <p><i>edia</i></p> <p>B: ca. 7 mm, Ø ca. 12 mm</p> <p>E646 45,00 €</p>
<p>matt/poliert</p>  <p><i>edia</i></p> <p>B: ca. 3 mm, Ø ca. 16 mm</p> <p>E652 45,00 €</p>	<p>matt/poliert</p>  <p><i>edia</i></p> <p>B: ca. 5 mm, Ø ca. 16 mm</p> <p>E658 48,00 €</p>	<p>matt/poliert</p>  <p><i>edia</i></p> <p>B: ca. 7 mm, Ø ca. 16 mm</p> <p>E664 51,00 €</p>
<p>gekratzt/poliert</p>  <p><i>edia</i></p> <p>B: ca. 3 mm, Ø ca. 12 mm</p> <p>E636 39,00 €</p>	<p>gekratzt/poliert</p>  <p><i>edia</i></p> <p>B: ca. 5 mm, Ø ca. 12 mm</p> <p>E642 42,00 €</p>	<p>gekratzt/poliert</p>  <p><i>edia</i></p> <p>B: ca. 7 mm, Ø ca. 12 mm</p> <p>E648 45,00 €</p>
<p>gekratzt/poliert</p>  <p><i>edia</i></p> <p>B: ca. 3 mm, Ø ca. 16 mm</p> <p>E654 45,00 €</p>	<p>gekratzt/poliert</p>  <p><i>edia</i></p> <p>B: ca. 5 mm, Ø ca. 16 mm</p> <p>E660 48,00 €</p>	<p>gekratzt/poliert</p>  <p><i>edia</i></p> <p>B: ca. 7 mm, Ø ca. 16 mm</p> <p>E666 51,00 €</p>

poliert, Gelbgold
beschichtet



evia

B: ca. 3 mm,
Ø ca. 12 mm

E633
49,00 €

poliert, Gelbgold
beschichtet



evia

B: ca. 5 mm,
Ø ca. 12 mm

E639
54,00 €

poliert, Gelbgold
beschichtet



evia

B: ca. 7 mm,
Ø ca. 12 mm

E645
59,00 €

poliert, Gelbgold
beschichtet



evia

B: ca. 3 mm,
Ø ca. 16 mm

E651
55,00 €

poliert, Gelbgold
beschichtet



evia

B: ca. 5 mm,
Ø ca. 16 mm

E657
60,00 €

poliert, Gelbgold
beschichtet



evia

B: ca. 7 mm,
Ø ca. 16 mm

E663
65,00 €

matt/polier, Gelbgold
beschichtet



evia

B: ca. 3 mm,
Ø ca. 12 mm

E635
49,00 €

matt/polier, Gelbgold
beschichtet



evia

B: ca. 5 mm,
Ø ca. 12 mm

E641
54,00 €

matt/polier, Gelbgold
beschichtet



evia

B: ca. 7 mm,
Ø ca. 12 mm

E647
59,00 €

matt/polier, Gelbgold
beschichtet



evia

B: ca. 3 mm,
Ø ca. 16 mm

E653
55,00 €

matt/polier, Gelbgold
beschichtet



evia

B: ca. 5 mm,
Ø ca. 16 mm

E659
60,00 €

matt/polier, Gelbgold
beschichtet



evia

B: ca. 7 mm,
Ø ca. 16 mm

E665
65,00 €

gekratzt/polier, Gelbgold
beschichtet



evia

B: ca. 3 mm,
Ø ca. 12 mm

E637
49,00 €

gekratzt/polier, Gelbgold
beschichtet



evia

B: ca. 5 mm,
Ø ca. 12 mm

E643
54,00 €

gekratzt/polier, Gelbgold
beschichtet

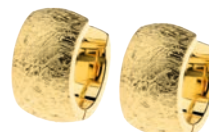

evia

B: ca. 7 mm,
Ø ca. 12 mm

E649
59,00 €

gekratzt/polier, Gelbgold
beschichtet



evia

B: ca. 3 mm,
Ø ca. 16 mm

E655
55,00 €

gekratzt/polier, Gelbgold
beschichtet



evia

B: ca. 5 mm,
Ø ca. 16 mm

E661
60,00 €

gekratzt/polier, Gelbgold
beschichtet



evia

B: ca. 7 mm,
Ø ca. 16 mm

E667
65,00 €

matt/polirt,
Brill. TW/SI 0,02 ct.,
Spiegelankerkette Ø 1 mm



L: ca. 16, 17, 18, 19, 20, 21 cm,
mit Clic-Verschluss Ø 2 mm

A571
176,00 €

matt/polirt,
Brill. TW/SI 0,02 ct.



B: ca. 2 mm,
klein, mittel, groß

A570
146,00 €

matt/polirt,
SW-Perle Ø ca. 4 mm,
Spiegelankerkette Ø 1 mm



L: ca. 16, 17, 18, 19, 20, 21 cm,
mit Clic-Verschluss Ø 2 mm

A572
95,00 €

matt/polirt



B: ca. 2 mm,
klein, mittel, groß

A573
69,00 €

polirt,
Brill. TW/SI 0,02 ct.,
Spiegelankerkette Ø 1 mm



L: 16, 17, 18, 19, 20, 21 cm,
mit Clic-Verschluss Ø 2 mm

A592
175,00 €

polirt



L: ca. 16, 17, 18, 19, 20, 21 cm,
mit Clic-Verschluss Ø 2 mm

A591
59,00 €

matt/polirt,
Spiegelankerkette Ø 1,5 mm



L: ca. 16, 17, 18, 19, 20, 21 cm,
mit Clic-Verschluss Ø 2 mm

A596
85,00 €

matt/polirt,
teilweise Gelbgold
beschichtet,
Spiegelankerkette Ø 1,5 mm



L: ca. 16, 17, 18, 19, 20, 21 cm,
mit Clic-Verschluss Ø 2 mm

A597
95,00 €

matt/gekratzt/polirt,
Spiegelankerkette Ø 1,5 mm



L: ca. 16, 17, 18, 19, 20, 21 cm,
mit Clic-Verschluss Ø 2 mm

A586
104,00 €

matt/gekratzt/polirt,
teilweise Gelbgold beschichtet,
Spiegelankerkette Ø 1,5 mm



L: ca. 16, 17, 18, 19, 20, 21 cm,
mit Clic-Verschluss Ø 2 mm

A587
116,50 €

matt/gekratzt/polirt,
teilweise Roségold beschichtet,
Spiegelankerkette Ø 1,5 mm



L: ca. 16, 17, 18, 19, 20, 21 cm,
mit Clic-Verschluss Ø 2 mm

A588
116,50 €

polirt, SW-Perle Ø ca. 4 mm,
Spiegelankerkette Ø 1,5 mm



L: ca. 16, 17, 18, 19, 20, 21 cm,
mit Clic-Verschluss Ø 2 mm

A593
95,00 €

poliert/gekratzt/matt,
Spiegelankerkette Ø 1,5 mm



L: ca. 16, 17, 18, 19, 20, 21 cm,
mit Clic-Verschluss Ø 2 mm

A594
104,00 €

matt/gekratzt/polirt,
teilweise Gelbgold
beschichtet,
Spiegelankerkette Ø 1,5 mm



L: ca. 16, 17, 18, 19, 20, 21 cm,
mit Clic-Verschluss Ø 2 mm

A595
116,00 €

matt/polirt/gekratzt



B: ca. 13 mm,
klein, mittel, groß

A589
109,00 €

matt/polirt/gekratzt,
teilweise Gelbgold beschichtet



B: ca. 13 mm,
klein, mittel, groß

A590
159,00 €

matt/polirt,
SW-Perle Ø ca. 8 mm



B: ca. 13 mm,
klein, mittel, groß

A48
146,00 €

matt, teilweise Gelbgold beschichtet,
SW-Perle Ø ca. 8 mm



B: ca. 13 mm,
klein, mittel, groß

A49
185,00 €

matt, Leder hellbraun,
dunkelbraun, schwarz



Ø ca. 6 mm,
L: ca. 19, 20, 21 cm

A55.HB A55.DB A55.SW
je 69,00 €

matt, Leder hellbraun,
dunkelbraun, schwarz



Ø ca. 6 mm,
L: ca. 19, 20, 21 cm

A56.HB A56.DB A56.SW
je 69,00 €

Königsarmband

matt/polirt



Ø ca. 9 mm,
L: ca. 19, 20, 21 cm,
mit Magnetverschluss groß mit Gewinde

A59
97,50 €

Olivenarmband

matt/polirt



Ø ca. 12 mm,
L: ca. 19, 20, 21 cm,
mit Magnetverschluss groß mit Gewinde

A87
120,50 €

Strickarmband

matt



Ø ca. 7 mm,
L: ca. 19, 20, 21 cm,
mit Magnetverschluss groß mit Gewinde

A73
66,00 €

matt/polirt



Ø ca. 12 mm,
L: ca. 19, 20, 21 cm,
mit Magnetverschluss groß mit Gewinde

A74
134,00 €

Königsarmband

matt/polier



Ø ca. 5 mm,
L: ca. 19, 20, 21 cm,
mit Magnetverschluss groß mit Gewinde

A79
85,50 €

Zopfarmband

matt/polier



Ø ca. 8 mm,
L: ca. 19, 20, 21 cm,
mit Magnetverschluss groß mit Gewinde

A81
78,50 €

matt/polier



Ø ca. 8 mm,
L: ca. 19, 20, 21 cm,
mit Magnetverschluss groß mit Gewinde

A91
97,50 €

matt, Leder hellbraun,
dunkelbraun, schwarz



Ø ca. 8 mm,
L: ca. 19, 20, 21 cm,
mit Magnetverschluss groß mit Gewinde

A60.HB A60.DB A60.SW
je 76,00 €

Königsarmband

matt/polier, teilweise
Gelbgold beschichtet



Ø ca. 9 mm,
L: ca. 19, 20, 21 cm,
mit Magnetverschluss groß mit Gewinde

A84
130,00 €

Königsarmband

matt/polier, teilweise
Roségold beschichtet



Ø ca. 9 mm,
L: ca. 19, 20, 21 cm,
mit Magnetverschluss groß mit Gewinde

A85
130,00 €

Königsarmband

matt/polier, teilweise
Schwarz beschichtet



Ø ca. 9 mm,
L: ca. 19, 20, 21 cm,
mit Magnetverschluss groß mit Gewinde

A86
130,00 €

Olivenarmband

matt/polier, teilweise
Gelbgold beschichtet



Ø ca. 12 mm,
L: ca. 19, 20, 21 cm,
mit Magnetverschluss groß mit Gewinde

A88
130,00 €

Olivenarmband

matt/polier, teilweise
Roségold beschichtet



Ø ca. 12 mm,
L: ca. 19, 20, 21 cm,
mit Magnetverschluss groß mit Gewinde

A89
130,00 €

antik-matt



Ø ca. 6 mm,
L: ca. 19, 20, 21, 22, 23 cm,
mit Magnetverschluss klein ohne Gewinde

A532
76,00 €

poliert



Ø ca. 6,5 mm,
L: ca. 19, 20, 21 cm,
mit Magnetverschluss klein ohne Gewinde

A533
123,00 €

matt/poliert



Ø ca. 8 mm,
L: ca. 19, 20, 21 cm,
mit Magnetverschluss klein ohne Gewinde

A528
97,50 €

matt/poliert



Ø ca. 5 mm,
L: ca. 19, 20, 21 cm,
mit Magnetverschluss klein ohne Gewinde

A529
66,00 €

Königsarmband

matt/poliert



Ø ca. 5 mm,
L: ca. 19, 20, 21 cm,
mit Magnetverschluss klein ohne Gewinde

A524
85,50 €

Königsarmband

matt/poliert, teilweise
Gelbgold beschichtet



Ø ca. 5 mm,
L: ca. 19, 20, 21 cm,
mit Magnetverschluss klein ohne Gewinde

A525
116,50 €

Königsarmband

matt/poliert, teilweise
Roségold beschichtet



Ø ca. 5 mm,
L: ca. 19, 20, 21 cm,
mit Magnetverschluss klein ohne Gewinde

A526
116,50 €

Königsarmband

matt/poliert, teilweise
Schwarz beschichtet



Ø ca. 5 mm,
L: ca. 19, 20, 21 cm,
mit Magnetverschluss klein ohne Gewinde

A527
116,50 €

antik-matt



Ø ca. 5 mm,
L: ca. 19, 20, 21, 22, 23 cm,
mit Magnetverschluss klein ohne Gewinde

A534
76,00 €

matt, black-cord



Ø ca. 6 mm,
L: ca. 19, 20, 21, 22, 23 cm,
mit Magnetverschluss klein ohne Gewinde

A542
76,00 €

matt, Schwarz beschichtet,
black-cord



Ø ca. 6 mm,
L: ca. 19, 20, 21, 22, 23 cm,
mit Magnetverschluss klein ohne Gewinde

A543
76,00 €

polierte Drachen-
Venen-Achat-Würfel



Ø ca. 8 mm,
L: ca. 19, 20, 21, 22, 23 cm,
mit Magnetverschluss klein ohne Gewinde

A541
79,00 €

matte Onyx-Perlen



Ø ca. 6 mm,
L: ca. 19, 20, 21, 22, 23 cm,
mit Magnetverschluss klein ohne Gewinde

A520
76,00 €

matte Onyx-Perlen



Ø ca. 8 mm,
L: ca. 19, 20, 21, 22, 23 cm,
mit Magnetverschluss klein ohne Gewinde

A521
78,50 €

matte Onyx-Linsen



Ø ca. 6 mm,
L: ca. 19, 20, 21, 22, 23 cm,
mit Magnetverschluss klein ohne Gewinde

A530
76,00 €

matte Onyx-Linsen



Ø ca. 8 mm,
L: ca. 19, 20, 21, 22, 23 cm,
mit Magnetverschluss klein ohne Gewinde

A531
78,50 €

matte Silberauge-Perlen



Ø ca. 6 mm,
L: ca. 19, 20, 21, 22, 23 cm,
mit Magnetverschluss klein ohne Gewinde

A535
76,00 €

matte Silberauge-Perlen



Ø ca. 8 mm,
L: ca. 19, 20, 21, 22, 23 cm,
mit Magnetverschluss klein ohne Gewinde

A536
79,00 €

matte Holzjaspis-Perlen



Ø ca. 6 mm,
L: ca. 19, 20, 21, 22, 23 cm,
mit Magnetverschluss klein ohne Gewinde

A537
76,00 €

matte Holzjaspis-Perlen



Ø ca. 8 mm,
L: ca. 19, 20, 21, 22, 23 cm,
mit Magnetverschluss klein ohne Gewinde

A538
79,00 €

matte Sodalith-Perlen



Ø ca. 6 mm,
L: ca. 19, 20, 21, 22, 23 cm,
mit Magnetverschluss klein ohne Gewinde

A539
76,00 €

matte Sodalith-Perlen



Ø ca. 8 mm,
L: ca. 19, 20, 21, 22, 23 cm,
mit Magnetverschluss klein ohne Gewinde

A540
79,00 €

Süßwasserperlen



Ø ca. 6 mm,
L: ca. 19, 20, 21 cm,
mit Magnetverschluss klein ohne Gewinde

A522
101,50 €

Süßwasserperlen



Ø ca. 8 mm,
L: ca. 19, 20, 21 cm,
mit Magnetverschluss klein ohne Gewinde

A523
164,00 €

poliert



B: ca. 2 mm,
klein, mittel, groß

A574
82,50 €

poliert



B: ca. 4 mm,
klein, mittel, groß

A577
88,00 €

poliert, Gelbgold beschichtet



B: ca. 2 mm,
klein, mittel, groß

A575
111,00 €

poliert, Gelbgold beschichtet



B: ca. 4 mm,
klein, mittel, groß

A578
119,00 €

poliert, Roségold beschichtet



B: ca. 2 mm,
klein, mittel, groß

A576
111,00 €

poliert, Roségold beschichtet



B: ca. 4 mm,
klein, mittel, groß

A579
119,00 €

poliert, Zirkonia white teilausgefasst



B: ca. 2 mm,
klein, mittel, groß

A580
130,00 €

poliert, Zirkonia white teilausgefasst



B: ca. 9 mm,
klein, mittel, groß

A583
178,50 €

poliert, Gelbgold beschichtet,
Zirkonia white teilausgefasst



B: ca. 2 mm,
klein, mittel, groß

A581
155,00 €

poliert, Gelbgold beschichtet,
Zirkonia white teilausgefasst



B: ca. 9 mm,
klein, mittel, groß

A584
218,50 €

poliert, Roségold beschichtet,
Zirkonia white teilausgefasst



B: ca. 2 mm,
klein, mittel, groß

A582
155,00 €

poliert, Roségold beschichtet,
Zirkonia white teilausgefasst



B: ca. 9 mm,
klein, mittel, groß

A585
218,50 €

matt/polier/
graviert/gekratzt



Ø ca. 58 mm / groß ca. 62 mm

A306
59,00 €

matt/polier/
graviert/gekratzt



Ø ca. 58 mm / groß ca. 62 mm

A206
59,00 €

matt/polier/
graviert/gekratzt



Ø ca. 58 mm / groß ca. 62 mm

A300
59,00 €

matt/polier/
graviert/geschliffen



Ø ca. 58 mm / groß ca. 62 mm

A209
59,00 €

matt/polier/graviert,
Zirkonia white



Ø ca. 58 mm / groß ca. 62 mm

A407.WH
69,00 €

matt/polier/graviert,
Zirkonia white



Ø ca. 58 mm / groß ca. 62 mm

A410.WH
78,50 €

poliert/graviert/gekratzt



L: variabel bis 21 cm

A554
69,00 €

poliert/graviert,
Zirkonia white



L: variabel bis 21 cm

A557.WH
86,50 €

poliert/graviert,
Zirkonia white



L: variabel bis 21 cm

A560.WH
96,00 €

matt/polier/graviert,
Crystal White Pearl



Ø ca. 58 mm / groß ca. 62 mm

A214.WHP
59,00 €

matt/polier/graviert,
Süßwasserperlen



Ø ca. 58 mm / groß ca. 62 mm

A215
95,00 €

matt/polier/graviert,
Süßwasserperlen



Ø ca. 58 mm / groß ca. 62 mm

A259
95,00 €

matt/polier/graviert,
matte Bergkristall-Perlen



Ø ca. 58 mm / groß ca. 62 mm

A250
70,50 €

matt/polier/graviert,
matte Onyx-Perlen



Ø ca. 58 mm / groß ca. 62 mm

A253
70,50 €

matt/polier/graviert,
matte Rauchquarz-Perlen



Ø ca. 58 mm / groß ca. 62 mm

A256
70,50 €

matt/polier/graviert/gekratzt,
Gelbgold beschichtet



Ø ca. 58 mm / groß ca. 62 mm

A307
70,50 €

matt/polier/graviert/gekratzt,
Gelbgold beschichtet



Ø ca. 58 mm / groß ca. 62 mm

A207
70,50 €

matt/polier/graviert/gekratzt,
Gelbgold beschichtet



Ø ca. 58 mm / groß ca. 62 mm

A301
70,50 €

matt/polier/graviert/geschliffen,
Gelbgold beschichtet



Ø ca. 58 mm / groß ca. 62 mm

A210
70,50 €

matt/polier/graviert,
Gelbgold beschichtet,
Zirkonia white



Ø ca. 58 mm / groß ca. 62 mm

A408.WH
78,50 €

matt/polier/graviert,
Gelbgold beschichtet,
Zirkonia white



Ø ca. 58 mm / groß ca. 62 mm

A411.WH
92,00 €

poliert/graviert/gekratzt,
teilweise Gelbgold
beschichtet



L: variabel bis 21 cm

A555
74,50 €

poliert/graviert,
teilweise Gelbgold
beschichtet, Zirkonia white



L: variabel bis 21 cm

A558.WH
95,00 €

poliert/graviert,
teilweise Gelbgold
beschichtet, Zirkonia white



L: variabel bis 21 cm

A561.WH
104,00 €

matt/polier/graviert,
Gelbgold beschichtet,
Crystal White Pearl



Ø ca. 58 mm / groß ca. 62 mm

A403.WHP
70,50 €

matt/polier/graviert,
Gelbgold beschichtet,
Süßwasserperlen



Ø ca. 58 mm / groß ca. 62 mm

A230
107,00 €

matt/polier/graviert,
Gelbgold beschichtet,
Süßwasserperlen



Ø ca. 58 mm / groß ca. 62 mm

A260
107,00 €

matt/polier/graviert,
Gelbgold beschichtet,
matte Bergkristall-Perlen



Ø ca. 58 mm / groß ca. 62 mm

A251
82,50 €

matt/polier/graviert,
Gelbgold beschichtet,
matte Onyx-Perlen



Ø ca. 58 mm / groß ca. 62 mm

A254
82,50 €

matt/polier/graviert,
Gelbgold beschichtet,
matte Rauchquarz-Perlen



Ø ca. 58 mm / groß ca. 62 mm

A257
82,50 €

matt/polier/graviert/gekratzt,
Roségold beschichtet



Ø ca. 58 mm / groß ca. 62 mm

A308
70,50 €

matt/polier/graviert/gekratzt,
Roségold beschichtet



Ø ca. 58 mm / groß ca. 62 mm

A208
70,50 €

matt/polier/graviert/gekratzt,
Roségold beschichtet



Ø ca. 58 mm / groß ca. 62 mm

A302
70,50 €

matt/polier/graviert/geschliffen,
Roségold beschichtet



Ø ca. 58 mm / groß ca. 62 mm

A211
70,50 €

matt/polier/graviert,
Roségold beschichtet,
Zirkonia white



Ø ca. 58 mm / groß ca. 62 mm

A409.WH
78,50 €

matt/polier/graviert,
Roségold beschichtet,
Zirkonia white



Ø ca. 58 mm / groß ca. 62 mm

A412.WH
92,00 €

poliert/graviert/gekratzt,
teilweise Roségold
beschichtet



L: variabel bis 21 cm

A556
74,50 €

poliert/graviert,
teilweise Roségold
beschichtet, Zirkonia white



L: variabel bis 21 cm

A559.WH
95,00 €

poliert/graviert,
teilweise Roségold
beschichtet, Zirkonia white



L: variabel bis 21 cm

A562.WH
104,00 €

matt/polier/graviert,
Roségold beschichtet,
Crystal White Pearl



Ø ca. 58 mm / groß ca. 62 mm

A404.WHP
70,50 €

matt/polier/graviert,
Roségold beschichtet,
Süßwasserperlen



Ø ca. 58 mm / groß ca. 62 mm

A231
107,00 €

matt/polier/graviert,
Roségold beschichtet,
Süßwasserperlen



Ø ca. 58 mm / groß ca. 62 mm

A261
107,00 €

matt/polier/graviert,
Roségold beschichtet,
matte Bergkristall-Perlen



Ø ca. 58 mm / groß ca. 62 mm

A252
82,50 €

matt/polier/graviert,
Roségold beschichtet,
matte Onyx-Perlen



Ø ca. 58 mm / groß ca. 62 mm

A255
82,50 €

matt/polier/graviert,
Roségold beschichtet,
matte Rauchquarz-Perlen



Ø ca. 58 mm / groß ca. 62 mm

A258
82,50 €

Leder braun

**FINE
STEEL
WORKS**



B: ca. 13 mm
L: 18/19/20/21 cm
mit Magnetverschluss flach

A551
63,00 €

Leder khaki

**FINE
STEEL
WORKS**



B: ca. 13 mm
L: 18/19/20/21 cm
mit Magnetverschluss flach

A552
63,00 €

Leder schwarz

**FINE
STEEL
WORKS**

B: ca. 13 mm
L: 18/19/20/21 cm
mit Magnetverschluss flach



A550
63,00 €

Leder anthrazit

**FINE
STEEL
WORKS**

B: ca. 13 mm
L: 18/19/20/21 cm
mit Magnetverschluss flach



A553
63,00 €

SPANGENMASSE

Originalgrößen

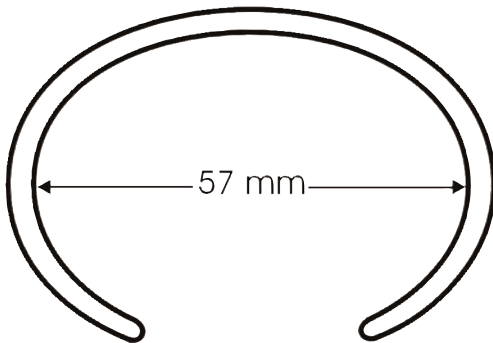

57 mm

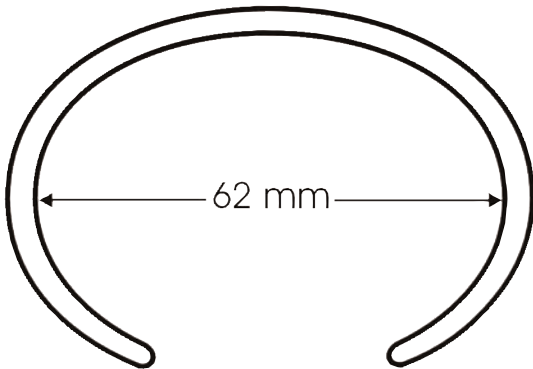

62 mm

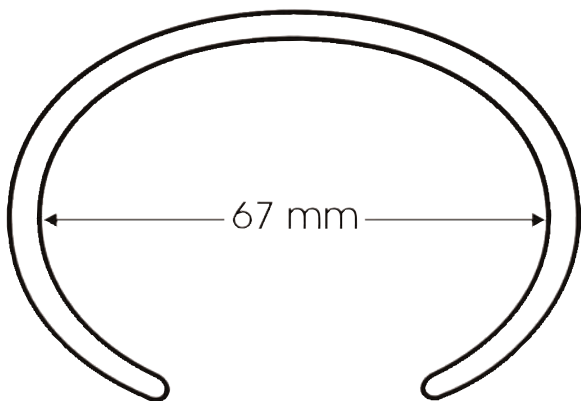

67 mm

SP1.8 57,50 €

SP2.7 67,50 €



Spiralseil, matt,
Ø ca. 1,8 mm mit Bajonett-Verschluss Ø 2 mm /
Ø ca. 2,7 mm mit Bajonett-Verschluss Ø 2,7 mm,
Preise bis 60 cm Länge

SP1.8C 70,00 €

SP2.7C 77,00 €



Spiralseil, matt,
Ø ca. 1,5 mm mit Clic-Verschluss Ø 2 mm /
Ø ca. 2 mm mit Clic-Verschluss Ø 2,5 mm,
Preise bis 60 cm Länge

SC1.8 41,00 €

SC2.7 46,50 €



Schlankenkette, poliert,
Ø ca. 1,8 mm mit Bajonett-Verschluss Ø 2 mm /
Ø ca. 2,7 mm mit Bajonett-Verschluss Ø 2,7 mm,
Preise bis 60 cm Länge

SC1.8C 53,50 €

SC2.7C 59,00 €



Schlankenkette, poliert,
Ø ca. 1,8 mm mit Clic-Verschluss Ø 2 mm /
Ø ca. 2,7 mm mit Clic-Verschluss Ø 3 mm,
Preise bis 60 cm Länge

SK4.5 126,00 €



Spiralkordel, matt,
Ø ca. 4,5 mm,
Preis bis 60 cm Länge,
mit Bajonett-Verschluss Ø 4,5 mm

DS0.63 38,00 €

DS0.63.GG 44,00 €

DS0.63.RG 44,00 €

Drahtseil, matt,
Gelb- oder Roségold
beschichtet, 1-fach,
Ø 0,63 mm
Preise bis 60 cm Länge,
mit Bajonett-Verschluss Ø 1,8 mm



DS0.63C 49,00 €

DS0.63C.GG 55,00 €

DS0.63C.RG 55,00 €

Drahtseil, matt,
Gelb- oder Roségold
beschichtet, 1-fach,
Ø 0,63 mm,
Preis bis 60 cm Länge,
mit Clic-Verschluss Ø 2 mm

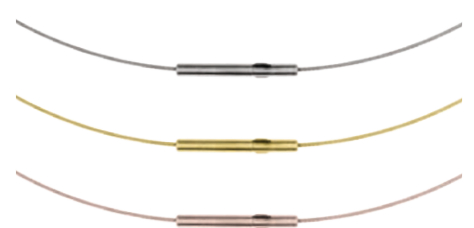

DS1 41,00 €

DS1.GG 45,00 €

DS1.RG 45,00 €

Drahtseil, matt,
Gelb- oder Roségold
beschichtet, 1-fach,
Ø 1 mm
Preise bis 60 cm Länge,
mit Bajonett-Verschluss Ø 1,8 mm



DS1C 53,50 €

DS1C.GG 57,50 €

DS1C.RG 57,50 €

Drahtseil, matt,
Gelb- oder Roségold
beschichtet, 1-fach,
Ø 1 mm,
Preise bis 60 cm Länge,
mit Clic-Verschluss Ø 2 mm



DS2 44,00 €

DS2.bi 46,50 €

DS2.rot 46,50 €

Drahtseil, matt, teilweise
Gelb- oder Roségold
beschichtet, 2-fach,
Preise bis 60 cm Länge,
mit Bajonett-Verschluss Ø 1,8 mm



DS2C 55,00 €

DS2C.Bi 59,00 €

DS2C.rot 59,00 €

Drahtseil, matt, teilweise
Gelb- oder Roségold
beschichtet, 2-fach,
Preise bis 60 cm Länge,
mit Clic-Verschluss Ø 2 mm

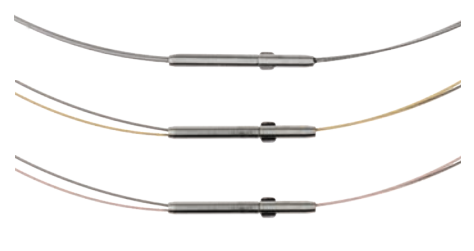

DS2.GG 50,50 €

DS2.RG 50,50 €

Drahtseil, matt,
Gelb- oder Roségold
beschichtet, 2-fach,
Preise bis 60 cm Länge,
mit Bajonett-Verschluss Ø 1,8 mm



DS2C.GG 64,50 €

DS2C.RG 64,50 €

Drahtseil, matt,
Gelb- oder Roségold
beschichtet, 2-fach,
Preise bis 60 cm Länge,
mit Clic-Verschluss Ø 2 mm

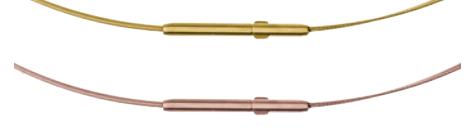

DS5 46,50 €

DS5.bi 55,00 €

DS5.rot 55,00 €

Drahtseil, matt, teilweise
Gelb- oder Roségold
beschichtet, 5-fach,
Preise bis 60 cm Länge,
mit Bajonett-Verschluss Ø 1,8 mm



DS5C 59,00 €

DS5C.Bi 67,50 €

DS5C.rot 67,50 €

Drahtseil, matt, teilweise
Gelb- oder Roségold
beschichtet, 5-fach,
Preise bis 60 cm Länge,
mit Clic-Verschluss Ø 2 mm

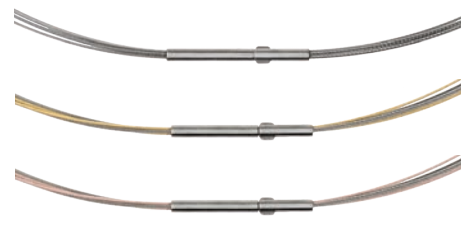

DS5.GG 66,00 €

DS5.RG 66,00 €

Drahtseil, matt,
Gelb- oder Roségold
beschichtet, 5-fach,
Preise bis 60 cm Länge,
mit Bajonett-Verschluss Ø 1,8 mm



DS5C.GG 76,00 €

DS5C.RG 76,00 €

Drahtseil, matt,
Gelb- oder Roségold
beschichtet, 5-fach,
Preise bis 60 cm Länge,
mit Clic-Verschluss Ø 2 mm



DS10 59,00 €

DS10.bi 67,50 €

DS10.rot 67,50 €

Drahtseil, matt, teilweise
Gelb- oder Roségold
beschichtet, 10-fach,
Preise bis 60 cm Länge,
mit Bajonett-Verschluss Ø 2,7 mm

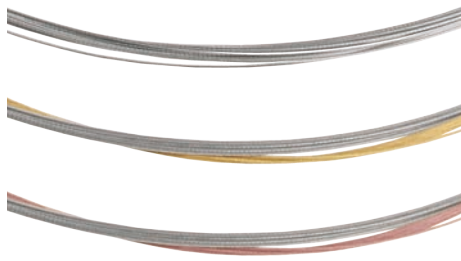

DS10C 70,50 €

DS10C.Bi 77,00 €

DS10C.rot 77,00 €

Drahtseil, matt, teilweise
Gelb- oder Roségold
beschichtet, 10-fach,
Preise bis 60 cm Länge,
mit Clic-Verschluss Ø 2,5 mm



DS10.GG 82,50 €

DS10.RG 82,50 €

Drahtseil, matt,
Gelb- oder Roségold
beschichtet, 10-fach,
Preise bis 60 cm Länge,
mit Bajonett-Verschluss Ø 2,7 mm



DS10C.GG 95,00 €

DS10C.RG 95,00 €

Drahtseil, matt,
Gelb- oder Roségold
beschichtet, 10-fach,
Preise bis 60 cm Länge,
mit Clic-Verschluss Ø 2,5 mm



DS20 101,50 €

DS20.bi 126,00 €

DS20.rot 126,00 €

Drahtseil, matt, teilweise
Gelb- oder Roségold
beschichtet, 20-fach,
Preise bis 60 cm Länge,
mit Bajonett-Verschluss Ø 3,5 mm



DS20C 113,50 €

DS20C.Bi 134,00 €

DS20C.rot 134,00 €

Drahtseil, matt, teilweise
Gelb- oder Roségold
beschichtet, 20-fach,
Preise bis 60 cm Länge,
mit Clic-Verschluss Ø 3,5 mm



DS20.GG 146,00 €

DS20.RG 146,00 €

Drahtseil, matt,
Gelb- oder Roségold
beschichtet, 20-fach,
Preise bis 60 cm Länge,
mit Bajonett-Verschluss Ø 3,5 mm



DS20C.GG 157,50 €

DS20C.RG 157,50 €

Drahtseil, matt,
Gelb- oder Roségold
beschichtet, 20-fach,
Preise bis 60 cm Länge,
mit Clic-Verschluss Ø 3,5 mm



DS35 157,50 €

DS35.bi 218,50 €

DS35.rot 218,50 €

Drahtseil, matt, teilweise
Gelb- oder Roségold
beschichtet, 35-fach,
Preise bis 60 cm Länge,
mit Bajonett-Verschluss Ø 4,5 mm



DS35.GG 272,00 €

DS35.RG 272,00 €

Drahtseil, matt,
Gelb- oder Roségold
beschichtet, 35-fach,
Preise bis 60 cm Länge,
mit Bajonett-Verschluss Ø 4,5 mm



AK1 41,00 €

AK13 56,00 €

AK14 56,00 €

Ankerkette, poliert,
Gelb- oder Roségold
beschichtet, Ø 2,5 mm,
Preise bis 60 cm Länge,
mit Bajonett-Verschluss Ø 1,8 mm



AK1C 53,50 €

Ankerkette, poliert, 1-fach,
Ø ca. 2,5 mm,
Preis bis 60 cm Länge,
mit Clic-Verschluss Ø 2 mm



AK2 46,50 €

AK15 63,00 €

AK16 63,00 €



Ankerkette, poliert,
Gelb- oder Roségold
beschichtet, Ø 4 mm,
Preise bis 60 cm Länge,
mit Bajonett-Verschluss 3,5 mm

AK2C 59,00 €



Ankerkette, poliert,
Ø ca. 4 mm,
Preis bis 60 cm Länge, mit
Clic-Verschluss Ø 3,5 mm

AK1.3 59,00 €



Ankerkette, poliert, 3-fach,
Ø je ca. 2,5 mm,
Preis bis 60 cm Länge,
mit Bajonett-Verschluss Ø 3,5 mm

AK4 53,50 €



Ankerkette,
Ø ca. 7 mm,
Preis bis 60 cm Länge,
mit Bajonett-Verschluss Ø 5,5 mm

AK5 49,00 €

Bajonett-Verschluss
Ø 1,8 mm

AK17 66,00 €

Bajonett-Verschluss
Ø 1,6 mm

AK18 66,00 €

Bajonett-Verschluss
Ø 1,6 mm



Spiegelankerkette, poliert, Gelb- oder Roségold beschichtet, Ø 1 mm,
Preise bis 60 cm Länge

AK5C 63,00 €



Spiegelankerkette, poliert,
Ø ca. 1 mm,
Preis bis 60 cm Länge, mit
Clic-Verschluss Ø 2 mm

AK6 53,50 €

Bajonett-Verschluss
Ø 1,8 mm

AK19 69,00 €

Bajonett-Verschluss
Ø 1,6 mm

AK20 69,00 €

Bajonett-Verschluss
Ø 1,6 mm



Spiegelankerkette, poliert, Gelb- oder Roségold beschichtet, Ø 2 mm,
Preise bis 60 cm Länge

AK6C 66,00



Spiegelankerkette, poliert,
Ø ca. 2 mm,
Preis bis 60 cm Länge, mit
Clic-Verschluss Ø 2 mm

AK7 56,00 €

AK21 70,50 €

AK22 70,50 €



Spiegelankerkette, poliert,
Gelb- oder Roségold
beschichtet, Ø 3 mm,
Preise bis 60 cm Länge,
mit Bajonett-Verschluss Ø 2,7 mm

AK7C 69,00



Spiegelankerkette,
poliert, Ø ca. 3 mm,
Preis bis 60 cm Länge,
mit Clic-Verschluss Ø 2,5 mm

AK8 59,00 €

AK23 73,00 €

AK24 73,00 €



Spiegelankerkette, poliert,
Gelb- oder Roségold
beschichtet, Ø 4 mm,
Preise bis 60 cm Länge,
mit Bajonett-Verschluss Ø 2,7 mm

AK8C 70,50



Spiegelankerkette,
poliert, Ø ca. 4 mm,
Preis bis 60 cm Länge,
mit Clic-Verschluss Ø 3 mm

AK9	59,00 €	
AK11	92,00 €	
AK12	92,00 €	

Zopf-kette, poliert,
Gelb- oder Roségold
beschichtet, Ø 4 mm,
Preise bis 60 cm Länge,
mit Bajonett-Verschluss Ø 4,5 mm

AK9C	70,50	
------	-------	--

Zopf-kette, poliert,
Ø ca. 4 mm,
Preis bis 60 cm Länge,
mit Clic-Verschluss Ø 3,5 mm

AK10	59,00 €	
AK34	78,50 €	
AK35	78,50 €	

Strickkette, poliert,
Gelb- oder Roségold
beschichtet, Ø 4 mm,
Preise bis 60 cm Länge,
mit Bajonett-Verschluss Ø 4,5 mm

AK10C	70,50 €	
-------	---------	---

Strickkette, poliert,
Ø 4 mm,
Preise bis 60 cm Länge,
mit Clic-Verschluss 4,5 mm

AK25	35,00 €	
AK26	49,00 €	
AK27	49,00 €	

Kugelkette, poliert,
Gelb- oder Roségold
beschichtet, Ø 1,5 mm,
Preise bis 60 cm Länge,
mit Bajonett-Verschluss Ø 1,8 mm

AK25C	46,50	
-------	-------	---

Kugelkette, poliert,
Ø ca. 1,5 mm,
Preis bis 60 cm Länge,
mit Clic-Verschluss Ø 2 mm

AK28	38,00 €	
AK29	53,50 €	
AK30	53,50 €	

Kugelkette, poliert,
Gelb- oder Roségold
beschichtet, Ø 2 mm,
Preise bis 60 cm Länge,
mit Bajonett-Verschluss Ø 1,8 mm

AK28C	49,00	
-------	-------	---

Kugelkette, poliert,
Ø ca. 2 mm,
Preis bis 60 cm Länge,
mit Clic-Verschluss Ø 2 mm

AK31	41,00 €	
AK32	59,00 €	
AK33	59,00 €	

Kugelkette, poliert,
Gelb- oder Roségold
beschichtet, Ø 2,4 mm,
Preise bis 60 cm Länge,
mit Bajonett-Verschluss Ø 2,7 mm

AK31C	53,50	
-------	-------	---

Kugelkette, poliert,
Ø ca. 2,4 mm,
Preis bis 60 cm Länge,
mit Clic-Verschluss Ø 2 mm

AK36	69,00 €	
AK37	82,50 €	
AK38	82,50 €	

Kugel-Ankerkette, poliert,
Gelb- oder Roségold
beschichtet, Ø ca. 1 mm,
Preise bis 60 cm Länge,
mit Bajonett-Verschluss Ø 1,6 mm

--	--	--

AK39 56,00 €



Venezianerkette, poliert,
Ø 2 mm,
Preis bis 60 cm Länge,
mit Bajonett-Verschluss Ø 2,7 mm

AK39C 69,00 €



Venezianerkette, poliert,
Ø 2 mm,
Preis bis 60 cm Länge,
mit Clic-Verschluss Ø 2,5 mm

AK42 50,50 €



AK43 67,50 €

AK44 67,50 €



Spiegelankerkette, poliert,
Gelb- oder Roségold
beschichtet, Ø ca. 1,5 mm,
Preise bis 60 cm Länge,
mit Bajonett-Verschluss 2 mm

AK42C 64,50 €



Spiegelankerkette, poliert,
Ø ca. 1,5 mm,
Preise bis 60 cm Länge,
mit Clic-Verschluss 2 mm

L2.HB 35,00 €



L2.DB 35,00 €



L2 35,00 €



Lederband, hellbraun,
dunkelbraun, schwarz, Ø 2 mm,
Preise bis 60 cm Länge,
mit Bajonett-Verschluss 2,7 mm

L2.HBC 46,50 €



L2.DBC 46,50 €



L2C 46,50 €



Lederband, hellbraun,
dunkelbraun, schwarz,
Ø 2 mm,
Preise bis 60 cm Länge,
mit Clic-Verschluss Ø 2,5 mm

LG4.HB 53,50 €



LG4.DB 53,50 €



LG4.SW 53,50 €



Lederband, hellbraun,
dunkelbraun, schwarz,
Ø 4 mm,
Preise bis 60 cm Länge,
mit Bajonett-Verschluss Ø 4,5 mm

LG4C.HB 66,00 €



LG4C.DB 66,00 €



LG4C.SW 66,00 €



Lederband, hellbraun,
dunkelbraun, schwarz,
Ø 4 mm,
Preise bis 60 cm Länge,
mit Clic-Verschluss Ø 4,5 mm

KS2 35,00 €



KS3 39,50 €



KS4 44,00 €



Kautschukseil, schwarz,
Ø 2/3/4 mm,
Preise bis 60 cm Länge,
mit Bajonett-Verschluss Ø 2,7/3,5/4,5 mm

KS2C 46,50 €



KS3C 50,50 €



KS4C 55,00 €



Kautschukseil, schwarz,
Ø 2/3/4 mm,
Preise bis 60 cm Länge,
mit Clic-Verschluss Ø 2,5/3,5/4,5 mm

KS3fach 46,50 €



Kautschukseil, schwarz,
3-fach,
Preise bis 60 cm Länge,
mit Bajonett-Verschluss 4,5 mm

ENTWURF UND HERSTELLUNG

Andreas Ernst

ernstesdesign.de

PRODUKTEIGENSCHAFTEN:

- chirurgischer Edelstahl
- kein Anlaufen, kein Oxidieren des Edelstahls
- lange Lebensdauer
- pflegeleicht

ANGABEN ÜBER APPLIKATIONEN:

- 585er Gelbgold oder Roségold
- hochwertige Beschichtungen
- Platin 960, Platin 600
- Qualität der Brillanten TW/SI
- Carré-Diamanten in der Qualität TW/SI mit dem Schliff „princess cut“.
- Süßwasserzuchtperlen

ANGABEN ZU DEN KETTEN UND SEILEN:

- geliefert wird eine Standardlänge von 42 cm, wenn nicht anders bestellt
- Preise gelten bis zur angegebenen Länge
- Sonder- und Zwischenlängen möglich, Preise auf Anfrage, Umtausch/Rücknahme ausgeschlossen
- die Collier-Sets K600.S bis K681.S beinhalten einen silk wood Außenrahmen, einen Anhänger und ein Lederband in den abgebildeten Farben

ANGABEN ZU DEN RINGEN:

- erhältliche Ringgrößen siehe Artikelbeschreibungen
- Farbabweichungen vorbehalten
- Kein silk wood Schmuckstück gleicht dem anderen. Die Struktur des Materials ist immer ein wenig anders - Farb- und Musterabweichungen sind daher normal und müssen akzeptiert werden.
- Sonderanfertigungen möglich, Preise auf Anfrage, Umtausch/Rücknahme ausgeschlossen

ANGABEN ZU DEN ARMSPANGEN und ARMBÄNDERN:

- Armspangen sind in den Größen klein, mittel und groß erhältlich, siehe Originalgröße auf Seite 37
- Standardlängen der Armbänder: 19 cm, 20 cm, 21 cm (wenn nicht anders angegeben); Preise gelten bis 25 cm Länge
- Sonder- und Zwischenlängen möglich, Preise auf Anfrage, Umtausch/Rücknahme ausgeschlossen
- abweichend hiervon sind die Armbänder A550-A553 ausschließlich in den Längen 18 cm, 19 cm, 20 cm und 21 cm erhältlich!

ANGABEN ZU DEN ANHÄNGERN:

- Anhänger werden ohne Seile und Ketten geliefert
- Sonderanfertigungen möglich, Preise auf Anfrage, Umtausch/Rücknahme ausgeschlossen

ANGABEN ZU SCHMUCKSTÜCKEN MIT MAGNET:

- Bitte beachten Sie, dass Magnetfelder Datenträger wie Festplatten, Disketten, Scheckkarten mit Magnetstreifen, Audio- und Videokassetten usw. löschen, elektronische und mechanische Komponenten wie Herzschrittmacher, Uhren, Zähler, Kompass, Monitore, usw. beeinflussen bzw. zerstören können.

GRAVUREN:

- Wir bieten Ihnen durch moderne Techniken eine Vielzahl von Gravur-Möglichkeiten an. Bei Ringen ist die Innenfläche ab einer Profilhöhe von 3,5 mm gravierbar. Es können aber auch andere Schmuckstücke individuell graviert werden. Weitere Informationen finden Sie in unseren Gravur-Merkblättern. Sprechen Sie uns gerne an!

ALLGEMEINE HINWEISE:

- Vermeiden Sie den Kontakt der Schmuckstücke mit Chemikalien wie z.B. Reinigungsmitteln, oder flüssigen Kosmetikartikeln wie Parfums etc.
- Benutzen Sie zur Reinigung ein weiches Tuch, warmes Wasser und etwas Spülmittel.
- Auf Reisen transportieren Sie Ihre Schmuckstücke bitte getrennt voneinander.
- Perlen, Steine, Halbedelsteine und Leder sind Naturprodukte, die in Farbe und Beschaffenheit variieren können.
- Die Schmuckstücke sowie deren Beschichtungen können durch das Tragen Kratzer/Abnutzungen aufweisen. Wie schnell das geht, hängt von der Beanspruchung des Schmuckstücks ab. Dies sind normale Tragespuren und daher kein Reklamationsgrund. Bitte beachten Sie hierzu auch die Bestimmungen in unserer Garantiekarte.

PREISSTELLUNG:

- Angaben UVP (unverbindliche Preisempfehlung) in Euro inklusive MwSt.
- Änderungen sowie Irrtümer behalten wir uns vor.

Stand: September 2023

ED **vita**

ED **vita** petit

evia

**FINE
STEEL
WORKS**

ERNSTES  DESIGN
JEWELRY MADE IN GERMANY